

# VACUUM CONTROLLER

*CVC 3000*



## Instructions for use



## **Original instructions Keep for further use!**

*This manual is only to be used and distributed in its complete and original form. It is strictly the user's responsibility to carefully check the validity of this manual with respect to the product.*

Manufacturer:

**VACUUBRAND GMBH + CO KG**  
**Alfred-Zippe-Str. 4**  
**97877 Wertheim**  
**GERMANY**

Phone:

Head office +49 9342 808-0  
Sales +49 9342 808-5550  
Service +49 9342 808-5660

Fax: +49 9342 808-5555

Email: [info@vacuubrand.com](mailto:info@vacuubrand.com)

Web: [www.vacuubrand.com](http://www.vacuubrand.com)

*Thank you for purchasing this product from **VACUUBRAND GMBH + CO KG**. You have chosen a modern and technically high quality product.*

# TABLE OF CONTENT

|          |   |           |
|----------|---|-----------|
| <b>1</b> | <b>Introduction</b>                           | <b>7</b>  |
| 1.1      | User information . . . . .                    | 7         |
| 1.2      | About this document. . . . .                  | 8         |
| 1.2.1    | Display conventions . . . . .                 | 8         |
| 1.2.2    | Symbols and icons . . . . .                   | 9         |
| 1.2.3    | Handling instructions (action steps). . . . . | 10        |
| 1.2.4    | Abbreviations . . . . .                       | 11        |
| 1.2.5    | Term definition . . . . .                     | 11        |
| <b>2</b> | <b>Safety instructions</b>                    | <b>12</b> |
| 2.1      | Working conditions . . . . .                  | 12        |
| 2.1.1    | Intended use . . . . .                        | 12        |
| 2.1.2    | Improper use. . . . .                         | 12        |
| 2.1.3    | Foreseeable misuse . . . . .                  | 13        |
| 2.2      | Target groups . . . . .                       | 14        |
| 2.2.1    | User permissions . . . . .                    | 14        |
| 2.2.2    | Personal responsibility . . . . .             | 14        |
| 2.3      | Safety precautions . . . . .                  | 15        |
| 2.3.1    | Protective clothing. . . . .                  | 15        |
| 2.3.2    | Eliminate sources of danger . . . . .         | 15        |
| 2.4      | Safety and service . . . . .                  | 18        |
| 2.4.1    | Meaning Health and Safety Clearance . . . . . | 18        |
| 2.4.2    | Requirements for services . . . . .           | 19        |
| 2.5      | Environmental protection . . . . .            | 20        |
| <b>3</b> | <b>Product description</b>                    | <b>21</b> |
| 3.1      | Vacuum controller CVC 3000 . . . . .          | 21        |
| 3.2      | Functionality . . . . .                       | 23        |
| 3.3      | Operation modes . . . . .                     | 24        |
| <b>4</b> | <b>Installation and connection</b>            | <b>25</b> |
| 4.1      | Installation . . . . .                        | 25        |
| 4.1.1    | Table top version. . . . .                    | 25        |
| 4.1.2    | Built-in version . . . . .                    | 26        |
| 4.1.3    | Direct installation. . . . .                  | 26        |
| 4.1.4    | Examples of use . . . . .                     | 27        |
| 4.2      | Connection . . . . .                          | 29        |
| 4.2.1    | Electrical connection. . . . .                | 29        |
| 4.2.2    | Vacuum connection . . . . .                   | 31        |
| 4.2.3    | VACUU·BUS® . . . . .                          | 33        |

|          |   |           |
|----------|---|-----------|
| <b>5</b> | <b>Operating and display elements</b>                             | <b>35</b> |
| 5.1      | Operating elements . . . . .                                      | 35        |
| 5.1.1    | Selection knob . . . . .  | 35        |
| 5.1.2    | Control panel . . . . .   | 35        |
| 5.1.3    | Key combinations . . . . .  | 36        |
| 5.2      | Display and user interface . . . . .                              | 37        |
| 5.2.1    | Pressure display . . . . .  | 37        |
| 5.2.2    | Display icons . . . . .   | 38        |
| 5.2.3    | Signal sounds (warning beep) . . . . .                            | 40        |
| 5.2.4    | Menu display in general . . . . .                                 | 41        |
| 5.3      | Handling CVC 3000 . . . . .                                       | 42        |
| <b>6</b> | <b>Operation</b>  | <b>45</b> |
| 6.1      | Switch-on/-off controller . . . . .                               | 45        |
| 6.2      | Select language and pressure unit . . . . .                       | 46        |
| 6.3      | Mode – Operation mode . . . . .                                   | 47        |
| 6.3.1    | Select operation mode . . . . .                                   | 47        |
| 6.3.2    | Mode menu . . . . .   | 48        |
| 6.4      | Start controlling . . . . .                                       | 49        |
| 6.5      | Control during operation . . . . .                                | 49        |
| 6.5.1    | Venting (VENT) . . . . .  | 49        |
| 6.5.2    | Change operation mode . . . . .                                   | 51        |
| 6.5.3    | Display graphic (curve) . . . . .                                 | 53        |
| 6.5.4    | Quit display graphic . . . . .                                    | 54        |
| 6.6      | Quick adaption during operation . . . . .                         | 55        |
| 6.6.1    | Set vacuum . . . . .  | 55        |
| 6.6.2    | Motor speed ( <i>only VARIO®</i> ) . . . . .                      | 56        |
| 6.7      | Stop control . . . . .  | 56        |
| <b>7</b> | <b>Advanced menus and operation</b>                               | <b>57</b> |
| 7.1      | Operation menus . . . . .   | 57        |
| 7.1.1    | Pump down . . . . .   | 58        |
| 7.1.2    | Vac control . . . . .   | 59        |
| 7.1.3    | Auto mode (only valid for VARIO® pump) . . . . .                  | 60        |
| 7.1.4    | Program . . . . .   | 61        |
| 7.1.5    | VACUULAN . . . . .  | 62        |
| 7.2      | <i>Program functions (see Online version of CVC manual) . . .</i> | <i>62</i> |

|           |  |           |
|-----------|--|-----------|
| 7.3       | Configuration menu . . . . .   | 63        |
| 7.3.1     | Content selection . . . . .  | 64        |
| 7.3.2     | Submenus. . . . .  | 65        |
| 7.4       | <i>Function menu (see Online version of CVC manual)</i> . . . . .      | 68        |
| 7.5       | <i>Program functions (see Online version of CVC manual)</i> . . . . .  | 68        |
| <b>8</b>  | <b>Resolving problems</b>  | <b>69</b> |
| 8.1       | Error display . . . . .  | 69        |
| 8.2       | Fault – Cause – Remedy . . . . .                                       | 71        |
| 8.3       | Controller Reset . . . . .   | 75        |
| 8.4       | Error of external components . . . . .                                 | 77        |
| <b>9</b>  | <b>Cleaning and maintenance</b>  | <b>78</b> |
| 9.1       | Cleaning . . . . .   | 78        |
| 9.1.1     | Controller . . . . .   | 78        |
| 9.1.2     | Venting valve. . . . .   | 78        |
| 9.1.3     | Internal sensor . . . . .  | 78        |
| 9.2       | Sensor readjustment . . . . .  | 79        |
| <b>10</b> | <b>Appendix</b>  | <b>82</b> |
| 10.1      | Technical information . . . . .  | 82        |
| 10.1.1    | Technical data. . . . .  | 82        |
| 10.1.2    | Product comparison CVC 3000 . . . . .                                  | 84        |
| 10.1.3    | Rating plate. . . . .  | 85        |
| 10.1.4    | Wetted parts . . . . .   | 85        |
| 10.2      | <i>Interface commands (see Online version of CVC manual)</i> . . . . . | 86        |
| 10.2.1    | Pin assignment (RS232) . . . . .                                       | 86        |
| 10.3      | Ordering information. . . . .  | 87        |
| 10.4      | Service . . . . .  | 89        |
| 10.5      | Glossary . . . . .   | 90        |
| 10.6      | Index. . . . .   | 91        |
| 10.7      | Certifications . . . . .   | 93        |
| 10.7.1    | EC Declaration of Conformity . . . . .                                 | 93        |
| 10.7.2    | UKCA Declaration of Conformity . . . . .                               | 94        |
| 10.7.3    | US/CAN Certificate . . . . .   | 95        |
| 10.7.4    | Declaration of Conformity – China RoHS 2 . . . . .                     | 96        |



For detailed descriptions about programming, function menu with address assignment, differential pressure measurement, and interface commands,

→ see manual **#20901067 CVC3000\_ONLINE version**.

First steps (delivery status)

First steps on delivery status  
Select language and units

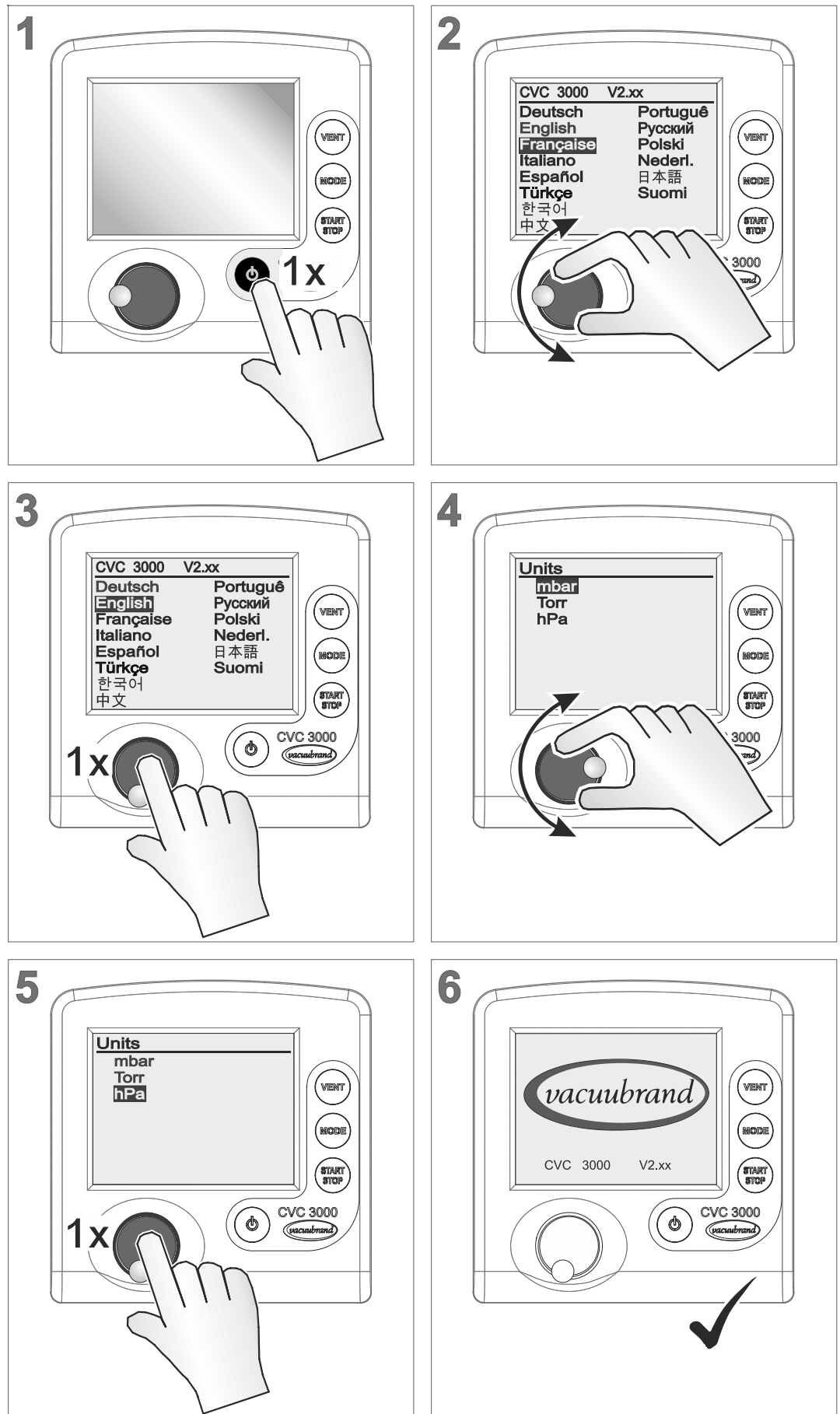

# 1 Introduction

This manual is part of your product. It provides important instructions for safe use of the product. Read this manual completely in order to understand proper use of your product.

## 1.1 User information

### Safety

---

Instructions for use  
and safety

- Read this manual thoroughly and completely before using the product.
- Keep this manual in an easily accessible location.
- Proper use of the product is essential for safe operation. Comply with all safety instructions provided!
- In addition to this manual, adhere to any relevant local accident prevention regulations and comply with industrial safety regulations.

### General

---

General  
information

- To make the text more readable in this manual, mostly the term **Controller** is used instead of **CVC 3000**.
- When giving the product to a third party also hand out these instructions for use.
- The illustrations in this manual are provided as examples. They are intended to aid in your understanding of the proper use of the product.
- **VACUUBRAND GMBH + CO KG** reserves the right to modify or change the product design and/or technical specifications at any time without advanced notice.

### Copyright

---

Copyright ©

The content of these instructions for use is protected by copyright. Only copies for internal use are allowed, e. g., for professional training.

© **VACUUBRAND GMBH + CO KG**

## Contact



- Contact us
- Please ask for replacement in case of an incomplete manual or download instructions for use on our web page: [www.vacuubrand.com](http://www.vacuubrand.com)
  - Contact us regarding any questions about this product, if you need further information, or to provide us with feedback.
  - When contacting our Customer Service Department, please be sure to have the correct type and serial number of your product → see *Rating plate*

## 1.2 About this document

### 1.2.1 Display conventions

#### Warning levels

Convention for warnings

|   |  |
|---|--|
|   | <b>DANGER</b>  |
|   | <p><b>Indicates an imminent hazardous situation.</b><br/>Disregarding the situation will result in serious and even fatal injury or death.</p> <p>⇒ Take appropriate action to avoid dangerous situation!</p>                  |
|   |  |
|  | <b>WARNING</b>   |
|   | <p><b>Indicates a potentially hazardous situation.</b><br/>Disregarding the situation could result in serious, even fatal injury or massive damage to property.</p> <p>⇒ Observe instruction to avoid dangerous situation!</p> |
|   |  |
|  | <b>CAUTION</b>   |
|   | <p><b>Indicates a potentially hazardous situation.</b><br/>Disregarding the situation could result in slight or minor injury or damage to property.</p> <p>⇒ Observe instruction to avoid dangerous situation!</p>             |
|   |  |



Convention for additional notes

|  |
|--|
| <b>NOTICE</b>  |
| <b>Notice for a potentially harmful situation.</b><br>Disregarding the notice could lead to material damage. |

**Additional notes**

**IMPORTANT!**

- ⇒ Information or specific use recommendation, which must be observed.
- ⇒ Important information for the proper operation.

|   |                           |
|---|---------------------------|
|  | ⇒ Helpful tips and tricks |
|   | ⇒ Additional information  |

**1.2.2 Symbols and icons**











This manual includes symbols and icons. Safety symbols indicate special danger in handling the product. Icons shall help to identify the danger directly and easier.

**Safety symbols**

Explanation of safety symbols

|  |   |  |  |
|--|---|--|--|
|  |  | acute toxicity – hazards to human health |  |
|  |  | general warning symbol                   |  |
|  |  | hot surface                              |  |
|  |  | general mandatory sign                   |  |

## Additional icons

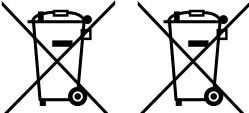
|                    |  |   |  |  |
|--------------------|--|---|--|--|
| References         |   | Positive example – <b>Do!</b><br>result – <b>o. k.</b>  |  | Negative example –<br><b>Do not!</b>     |
|                    |   | Refers to content of<br>this manual.  |  | Refers to content of<br>other documents. |
| Handling or action |   | <b>Press</b> selection knob or<br>key.  |  | <b>Turn</b> selection knob               |
|                    |   | <b>Push and hold</b> key  |  | <b>Push and turn</b> selection<br>knob   |
| Signals            |   | Flashing cycle – flashing icon indicating malfunction   |  |  |
|                    |   | Sound – signal or warning sound   |  |  |
|                    |  | Electric/electronic devices and batteries must not be<br>disposed of in the domestic waste at the end of their<br>service life. |  |  |



⇒ For further detailed information about icons and signals in the display see chapter **5.2.2 Display icons on page 38**.

### 1.2.3 Handling instructions (action steps)

Additional display  
conventions

#### **Action step** (single step)

⇒ Do the described step.

Result of action.

#### **Handling instructions**(multiple steps)

**1.** first step

**2.** next step

Result of action.

Follow steps in the described order.

### 1.2.4 Abbreviations

Abbreviations

|   |   |
|---|---|
| <b>abs.</b>   | absolute  |
| <b>ATM</b>  | Standard Atmospheric Pressure                           |
| <b>CVC 3000</b>   | Vakuum controller, Controller                           |
| <b>d<sub>i</sub></b> (di)   | Interior diameter                                       |
| <b>DN</b>   | Nominal diameter  |
|  | ATEX equipment labeling                                 |
| <b>EK</b>   | Emission condenser                                      |
| <b>EX*</b>  | Outlet  |
| <b>FKM</b>  | Fluorelastomer  |
| <b>Gr.</b>  | Size  |
| <b>hh:mm:ss</b>   | Time settings in hour/minute/second                     |
| <b>hPa</b>  | Pressure unit, hectopascal (1 hPa = 1 mbar = 0.75 Torr) |
| <b>IN*</b>  | Inlet   |
| <b>KF</b>   | Small flange  |
| <b>max.</b>   | Maximum value   |
| <b>mbar</b>   | Pressure unit, millibar (1 mbar = 1 hPa = 0.75 Torr)    |
| <b>min.</b>   | Minimum value   |
| <b>Min</b>  | Minute  |
| <b>PA</b>   | Polyamide   |
| <b>PBT</b>  | Polybutylene terephthalate                              |
| <b>PE</b>   | Polyethylene  |
| <b>respon.</b>  | responsible, supervising Specialist                     |
| <b>RMA-N°</b>   | Return Merchandise Authorization number                 |
| <b>SW</b>   | Wrench size (tool)                                      |
| <b>Torr</b>   | Pressure unit (1 Torr = 1.33 mbar = 1.33 hPa)           |
| <b>VAC</b>  | Vacuum  |
| <b>VMS</b>  | Vakuum Management System                                |

\* labeling on top of the vacuum pump

### 1.2.5 Term definition

Product specific terms

|                       |   |
|-----------------------|---|
| <b>...-I/O module</b> | Interface for an external peripheral device to connect with a <b>VACUU·BUS®</b> capable vacuum gauge or -controller |
| <b>VACUU·BUS®</b>     | Bus system by VACUUBRAND.   |
| <b>VACUU·CONTROL®</b> | Web-based application as remote control for vacuum controller and gauges made by VACUUBRAND.                        |
| <b>VACUU·LAN®</b>     | Local vacuum network for laboratories.  |
| <b>VARIO® control</b> | Precise vacuum control by motor speed control of VARIO® diaphragm pumps.  |

## 2 Safety instructions

All safety instructions must be observed by all individuals working with the product described here. The safety instructions are valid for the complete life cycle of the product.

### 2.1 Working conditions

Use the product only when it is in proper working condition.

#### 2.1.1 Intended use

Intended use The **Controller CVC 3000** is a laboratory instrument, used to measure and/or control vacuum in therefore intended plants. The controller may only be used in non-explosive areas and indoors. Any other use is considered to be improper use. In that case, the safety and the protection of the system may be compromised.

**Intended use also includes the following:**



- observing safety information of document “**Safety Information for Vacuum Equipment**“.
- observing this manual.
- observing the manual of connected elements and to know their functioning.

#### 2.1.2 Improper use

Using the product in contrary to its intended use could result in injury or damage to property.

**Improper use includes:**

- Improper use
- Using the product contrary to its intended use.
  - Operation with obvious malfunctions.

- Improper use
- Controlling explosive atmosphere, which does not compare to the ATEX approval of the **CVC 3000** → *see rating plate*.
  - Unauthorized modifications and the use of accessories and spare parts that are not recommended by the manufacturer.
  - Use in mining.

### 2.1.3 Foreseeable misuse



Additionally to improper use there are types of use and dealing with the product, which are generally prohibited:

Foreseeable misuse

- The control of media which is liquid, hot, instable, or explosive.
- Installation and operation in explosive environments.
- To switch on/-off by foot or with unsuitable tool.
- To operate the controller with sharp stylus or objects.
- To put the controller completely into vacuum.
- To immerse the controller into liquid or to blast it with steam.
- To use the remote control **VACUU·CONTROL**® with CVC 3000 without knowledge of the connected vacuum system.

## 2.2 Target groups

**IMPORTANT!**

Ensure that the controller is only operated by authorized and skilled personnel.

Users need to have the corresponding skills and qualifications for doing the job listed in the table *User permissions*.

### 2.2.1 User permissions

This manual must be read, understood and complied with by the person performing one of the following tasks:

Responsibility  
Assignment Matrix

| Task (Job)                | User | Specialist | Supervising Specialist |
|---------------------------|------|------------|------------------------|
| Installation and assembly |      | X          | X                      |
| Commissioning             |      | X          | X                      |
| Operation                 | X    | X          | X                      |
| Readjust vacuum sensor    |      | X          | X                      |
| Error report              | X    | X          | X                      |
| Troubleshooting           |      | X          | X                      |
| Update                    |      | X          | X                      |
| Cleaning, simple          | X    | X          | X                      |
| Clean vacuum sensor       |      | X          | X                      |
| Decontamination           |      |            | X*                     |
| Repair order              |      |            | X                      |

*\* or order the decontamination by a qualified service provider.*

### 2.2.2 Personal responsibility

Safe work

Personal safety has top priority. Processes which create a potentially hazardous situation are not allowed.

Always be conscious of safety, and work in a safe manner. Observe the owners' directives at work, the national accident prevention regulations and occupational safety provisions.

⇒ Use the controller only if you have understood its function and this manual.

## 2.3 Safety precautions

Quality standards  
and safety

Products of **VACUUBRAND GMBH + CO KG** are subject to high quality tests with goals for safety and operation. Prior to delivery each product has been tested thoroughly.

### 2.3.1 Protective clothing

Protective clothing

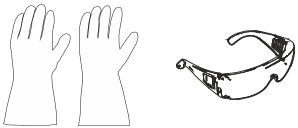

No special protective clothing is required when working with the controller. Observe the owners regulation for workplaces.

Only for cleaning the controller we recommend to wear protective gloves, protective clothing and safety goggles.

#### **IMPORTANT!**

- ⇒ Be sure to observe the local requirements for decontamination.
- ⇒ Wear your personal protective equipment when handling chemical materials.

### 2.3.2 Eliminate sources of danger

|   |   |
|---|---|
|  | <b>DANGER</b>   |
|   | <p><b>Explosion hazard for critical processes.</b><br/>Depending on the process explosive mixtures can develop.</p> <p>⇒ Never operate critical processes unattended!</p> |

Explosion danger for  
critical processes

Depending on the running process, explosive mixtures can form in plants or other hazardous situations could result!

#### **IMPORTANT!**

Malfunctions which may affect safety must be eliminated immediately.

- ⇒ Do not work with damaged components.
- ⇒ Replace defective parts immediately, e. g., broken cable or faulty plug-connection.

## Sources of error during connection

### NOTICE

#### Measuring error due to an obstructed vacuum line.

⇒ Prevent overpressure > 1060 mbar (> 795 Torr) in the piping system.

Condensate      Condensate can falsify the measurement. Position the vacuum hose in such a way that condensate cannot flow towards the controller and its vacuum sensor. No liquid should accumulate inside the vacuum hose.

⇒ Install vacuum hoses in such a way that condensate cannot flow into the controller.

Particles, liquids, dust      Particles, liquids or dust may not enter the controller.

⇒ Install a separator or filter at the intake of the system. Appropriate filters are for example chemically resistant, and resistant to clogging.

## Risks due to residual energy

Residual energy      After switching off the controller and disconnecting it from mains, risk of residual energy could still prevail at the power supply adapter.

⇒ Repairs may only be performed by qualified personnel, e. g., service technician.

### Option **CVC 3000 in combination with VACUU·CONTROL®**

**VACUU·CONTROL®** is a remote control for the controller. It is available as an accessory.

With this accessory a vacuum system can be operated simultaneously by controller or via **VACUU·CONTROL®**. Remote control is able to operate from several end devices, e. g., smart phone, tablet, or computer



**When using remote control please regard the following:**

- ⇒ Coordinate planned projects with colleagues sharing the equipment.
- ⇒ If necessary inform colleagues that you plan to use the remote control.
- ⇒ Avoid different, parallel settings.

**Installation and explosive environment**

**Installation and operation in areas where explosive atmospheres can occur is not allowed.**

**ATEX marking**

ATEX category



Controllers which are labeled with  $\epsilon x$  have an ATEX approval 3 G; i. e. flammable substances as mixture with air: pumped gas or vapor.

- ⇒ Use the controller only when it is in proper working condition.

**ATEX approval<sup>1</sup> is only valid for the internal, wetted parts area (vacuum sensor), not for the environment of the controller.**

ATEX category and peripherals

The ATEX category of the controller is dependent on the connected peripheral devices. Peripherals and connected devices to the controller need to have the same or must have a higher ATEX approval. Without concordant categorization of peripherals, the specified category of the VACUUBRAND equipment loses its validity.

Avoid ignition sources

The use of gas ballast or the operation of venting valves is only permitted if thereby explosive atmospheres normally do not occur in the interior of the equipment or, if they do occur, are likely to do so only infrequently and for a short period.

- ⇒ If necessary vent with inert gas.

For more and detailed information about ATEX approval visit our website: [www.vacuubrand.com/Information-ATEX](http://www.vacuubrand.com/Information-ATEX)

<sup>1</sup> -> compare to rating plate

Explanation of usage conditions X  
Example extract type plate

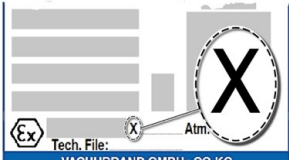

## Restrictions on operating conditions

Meaning for devices marked with X:

- The devices have a low mechanical protection and must be installed so that they cannot be mechanically damaged from the outside; e.g., installing pump stations with impact protection, attaching shatter protection for glass flasks, etc.
- The devices are designed for an ambient and media temperature of +10 °C to +40 °C during operation. These ambient and media temperatures must never be exceeded. When conveying/measuring non-explosive gases, extended gas suction temperatures apply, see chapter: Technical information, media temperature (gas).

## 2.4 Safety and service

Obligations for service jobs

Safety regulations that apply to your work environment also apply to persons who perform service works, especially in the handling of hazardous materials.

### 2.4.1 Meaning Health and Safety Clearance

Products which are potentially hazardous may only be returned when all dangerous contaminations are removed.

#### IMPORTANT!

- ⇒ Observe the requirements for services.
- ⇒ Observe the *Notes on return to the factory* listed on the form Health and Safety Clearance.
- ⇒ Protect the service personnel from hazardous substances.
- ⇒ Confirm harmlessness with your signature.



⇒ The form [Health and Safety Clearance](#) is also available on our website.

## 2.4.2 Requirements for services

### Fulfill the following conditions

1. Clean your product thoroughly and if necessary decontaminate it professionally.

**IMPORTANT!**

**For all service works hazardous substances need to be excluded.**

2. Fill in the form *Health and Safety Clearance* thoroughly and completely.
3. Contact your local supplier or our service department.
4. Request a **RMA-N°** for your **service order**.
5. **Before returning the product**, please **send the signed *Health and Safety Clearance*** form to your local supplier or our service department.

**IMPORTANT!**

**For all service works the safety clearance needs to be proofed and confirmed.**

⇒ Did your product get in touch with hazardous substances?  
Please wait for the release of reshipment.

6. Send in your product including:
  - RMA-N°,
  - Service order (e. g., repair),
  - Form *Health and Safety Clearance*,
  - Short description (e. g., malfunction, working environment, media).



Any more questions? We will help you:

Phone: +49 9342 808-5660

Fax: +49 9342 808-5555

[service@vacuubrand.com](mailto:service@vacuubrand.com)

## 2.5 Environmental protection

### **NOTICE**

#### **Risk of environmental damage due to incorrect disposal of the controller.**

- ⇒ Do not dispose your product in household waste!  
Electronic components are subject to hazardous waste treatment and must only be disposed of by certified specialists.
- ⇒ Observe the national regulations for safe disposal and environmental protection.
- ⇒ Receive detailed information about respective regulations from your competent administrative authority.



### 3 Product description

#### Goods arrival

Check incoming goods

Check the shipment for transport damage and completeness.  
 ⇒ Report any transit damage immediately to the supplier.

|  |
|--|
| <b>NOTICE</b>  |
| <p><b>Condensate can damage the controller.</b><br/>                 A large temperature difference between storage location and installation location can cause condensation.<br/>                 ⇒ Let the product acclimatize for 3–4 hours.</p> |

#### Included materials

Scope of supply

|  |  |
|--|--|
| <b>Controller</b>  |  |
| Vacuum controller CVC 3000                                       | see <i>Ordering information on page 85</i> |
| Power supply unit 30W 24V; including interchangeable mains plugs | 20612090                                   |
| Instructions for use   | 20901067                                   |
| Safety Information for Vacuum Equipment                          | 20999254                                   |
| Origin packaging   | -----                                      |

### 3.1 Vacuum controller CVC 3000

The controller is designed for applications requiring controlled vacuum.

The controller has a two-point control mode to switch an in-line isolation valve.

The controller is freely programmable. Up to 10 programs can be stored in the controller memory. Each program also offers up to 10 program steps (time/pressure) plus control functions, such as: venting, pump down and ramp function.

The controller enables the measurement of relative pressure with regard to a reference sensor (VSK 3000).

Front side

Front panel

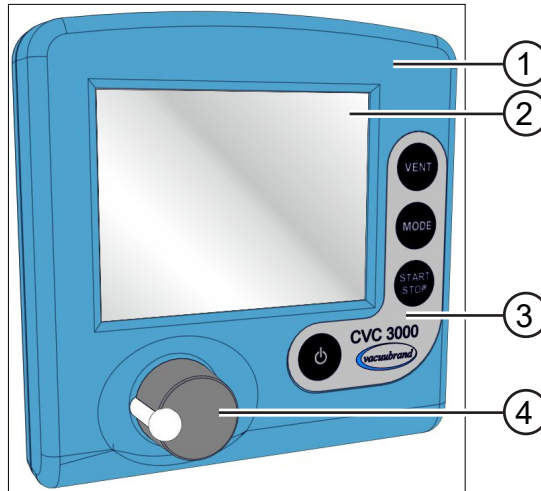

Meaning

- |   |                                      |
|---|--------------------------------------|
| 1 | Chemically resistant plastic housing |
| 2 | LC display                           |
| 3 | Control panel and product name       |
| 4 | Selection knob                       |

Rear side

Rear side

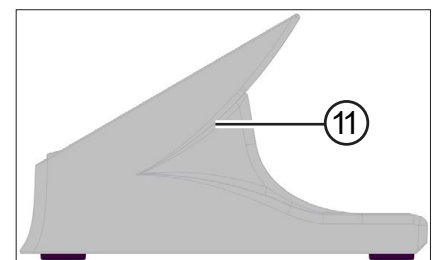
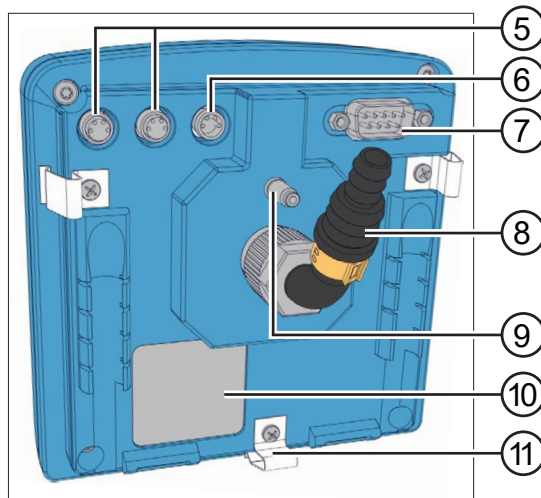

Meaning

- |    |  |
|----|--|
| 5  | Ports for <b>VACUU-BUS®</b> components   |
| 6  | Mains connection<br>▶ power supply unit<br>▶ <b>VARIO®</b> diaphragm pump or<br>▶ pumping system |
| 7  | Serial port RS 232 C (Sub-D)   |
| 8  | Hose nozzle, vacuum connection   |
| 9  | Venting tube, connection for external venting, e. g., inert gas                                  |
| 10 | Rating plate   |
| 11 | Spring clip as fixation for built-in version<br>or<br>plastic foot for table top version         |

## 3.2 Functionality

Functionality The controller manages vacuum processes by controlling vacuum pumps, in-line isolation- and/or air admittance valves. It controls process vacuum, cooling water and venting to demand.



Valves and/or vacuum pumps are necessary to operate the controller.

**Without those components the controller can only be used as vacuum measurement device.**

## Specification

Specification and features

- Ceramic diaphragm vacuum sensor<sup>1</sup> and venting valve are already integrated into the controller.
- The ceramic vacuum sensor is chemically highly resistant, measures accurately and is gas-type independent.
- External valves, level sensors and vacuum sensors can be connected directly by **VACUU-BUS**® system, e. g., vacuum-, in-line isolation-, cooling- and air admittance valves as well as level sensors and emission condenser **Peltronic**®.
- While booting the controller checks for current configuration of connected components.
- Connected components are detected automatically due to **VACUU-BUS**® and controlled by the controller until the controller is switched off. Safety sensitive components stay configured and are monitored again after controller restart.
- Operating elements are the selection knob, buttons on the control panel and full text menus on the display.
- Port RS 232 can also be used for connecting the remote control **VACUU-CONTROL**®. The controller can be operated by one or several end devices, e.g., smartphone, tablet, computer.



<sup>1</sup> -> excluded for package fine vacuum control with VSP 3000.

### 3.3 Operation modes

Up to 5 different operation modes are selectable at the controller. Specific modifications can be realized by individual mode menus.

#### Selectable operation modes

---

- |            |  |
|------------|--|
| Standard   | <ul style="list-style-type: none"><li>▪ <b>Pump down</b></li><li>▪ <b>Vac control</b></li><li>▪ <b>Program</b></li></ul> |
| Optionally | <ul style="list-style-type: none"><li>▪ <b>Auto mode</b></li><li>▪ <b>VACUULAN</b></li></ul>                             |

For more information about individual operation modes  
→ see chapter *6.3.2 Mode menu on page 48*



## 4 Installation and connection

The controller is designed for installation directly at the workplace.



⇒ Observe all specifications for installation, connection and operation according to technical data,  
→ see *chapter 10.1.1 Technical data*.

⇒ Also observe rating plate data.

### Installation conditions

Consider installation conditions

- The controller has acclimatized.
- Ambient conditions are observed and are within the limitation of use.

| Limitation of use  |                           | (US)                       |
|--|---------------------------|----------------------------|
| Ambient temperature  | 10–40 °C                  | 50–104°F                   |
| Altitude, max.   | 3000 m<br>above sea level | 9840 ft<br>above sea level |
| Relative humidity  | 30–85 %, non condensing   |                            |
| Degree of protection (controller front)                                  | IP 20 (IP 42)             |                            |
| Avoid condensation or contamination by dust, liquids or corrosive gases. |                           |                            |

## 4.1 Installation

### 4.1.1 Table top version



The table top or bench-top type controller can be installed and connected directly on top of the work bench or on laboratory table. The table top version is supplied with a hose nozzle. The hose nozzle should be positioned in a way that the connected vacuum hose cannot kink.

### 4.1.2 Built-in version



The CVC 3000 can be used as built-in version fixed with spring clips; e. g., as front controller of a **VARIO**® pump, built into a cable duct cover or into the cut-out of a switch cabinet.

#### Cut-out for switch cabinet or cable duct cover

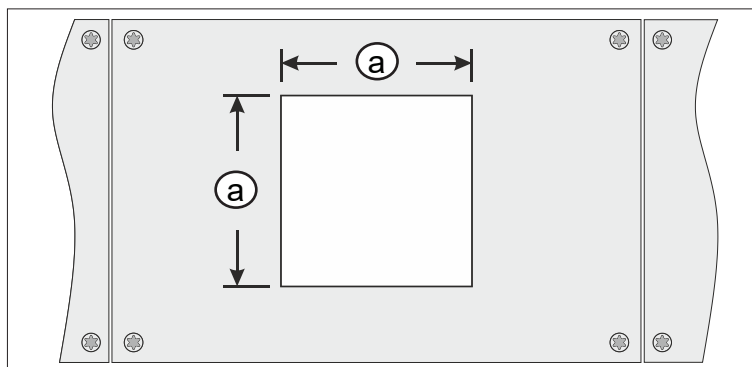

| Thickness |          | Size (a) for cut-out |                     |
|-----------|----------|----------------------|---------------------|
| 1 mm      | 0.04 in. | 111,5 mm x 111,5 mm  | 4.39 in. x 4.39 in. |
| 2 mm      | 0.08 in. | 112 mm x 112 mm      | 4.41 in. x 4.41 in. |
| 3 mm      | 0.12 in. | 112,5 mm x 112,5 mm  | 4.43 in. x 4.43 in. |

Depending on the wall thickness the cut-out size needs to be fitted.

### 4.1.3 Direct installation

The controller can be mounted directly at the vacuum vessel using a clamping ring

→ see also example *CVC 3000 directly installed on page 28* .

### 4.1.4 Examples of use

→ Example  
VARIO® pump with  
CVC 3000 and  
rotary evaporator

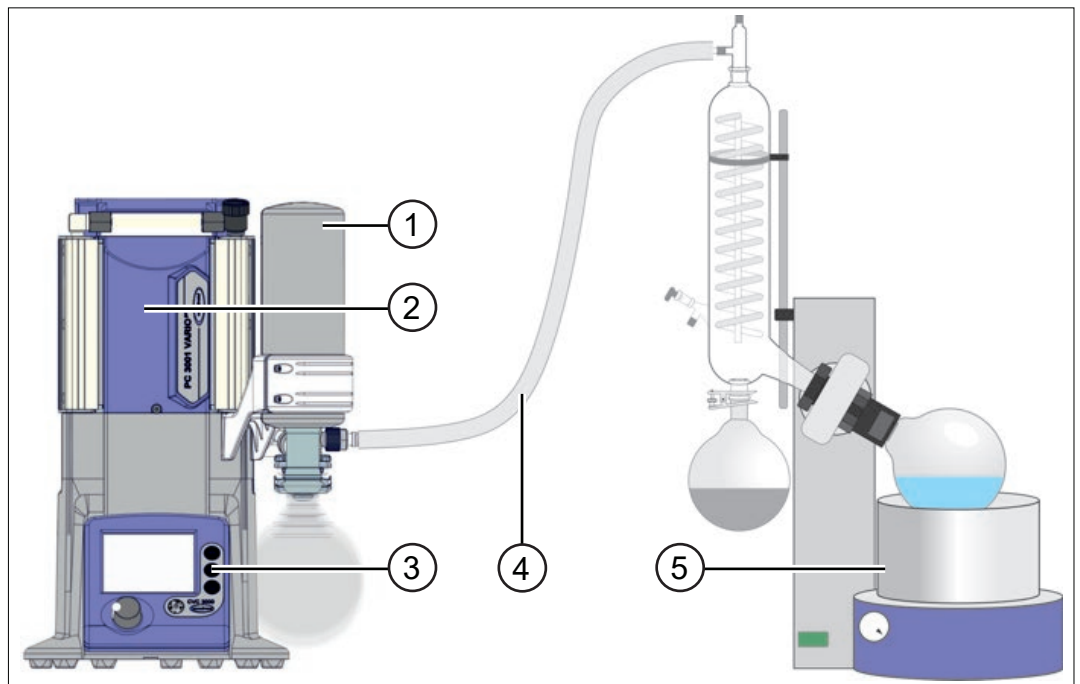

- 1 Emission condenser with round flask
- 2 **VARIO®** pump (PC 3001 **VARIO®**pro)
- 3 Controller CVC 3000, built-in version
- 4 Vacuum hose
- 5 Rotary evaporator

→ Example  
CVC 3000 build-up  
with cabinet dryer

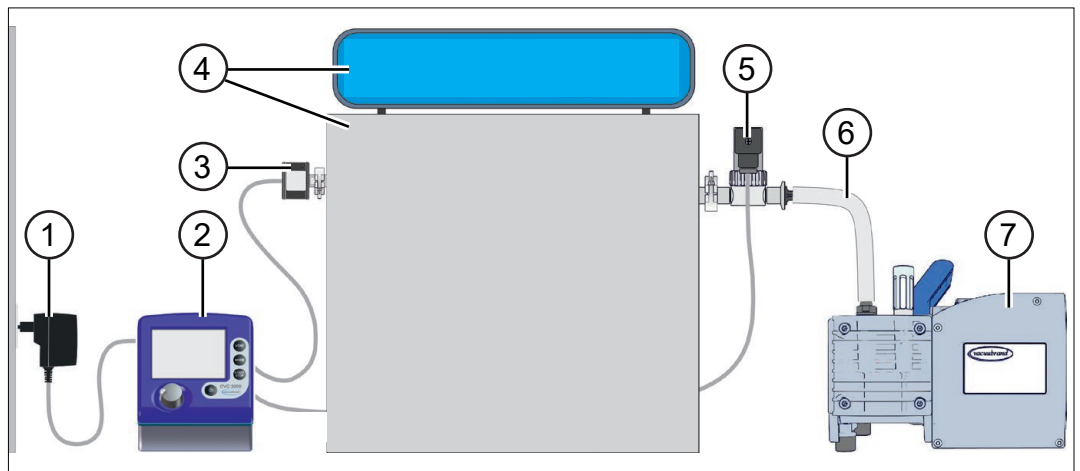

- 1 Wall power supply
- 2 Controller CVC 3000, table top version
- 3 Vacuum sensor (VSK)
- 4 Cabinet dryer with control unit on top
- 5 Vacuum valve
- 6 Vacuum hose
- 7 Diaphragm pump, vacuum pump

→ Example  
CVC 3000 directly  
installed

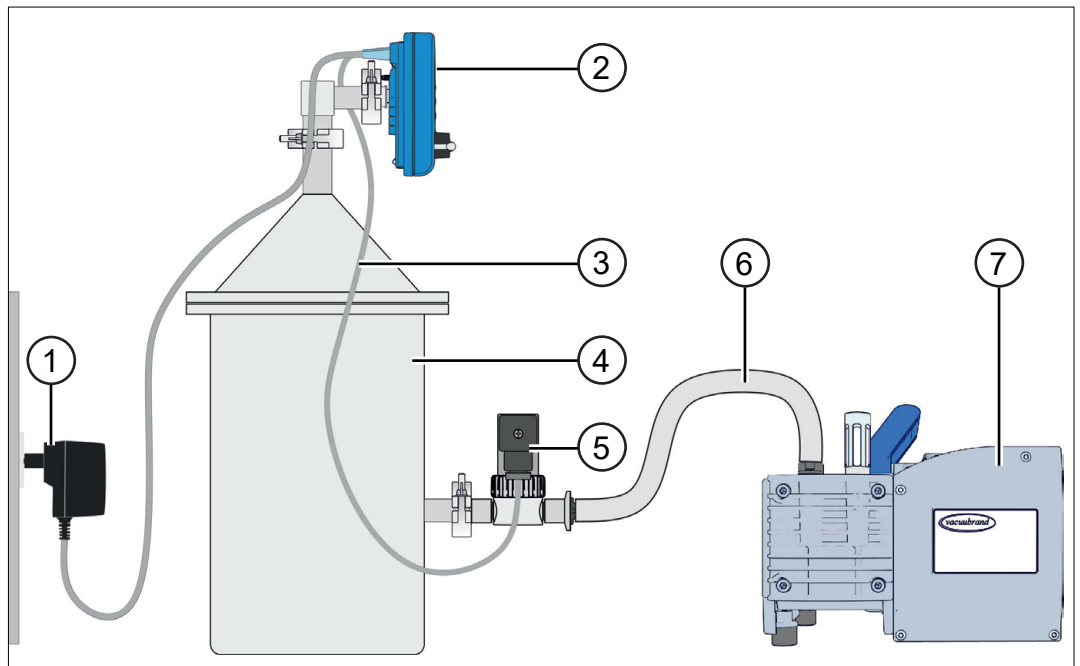

- |   |                                       |
|---|---------------------------------------|
| 1 | Wall power supply                     |
| 2 | Controller CVC 3000, directly mounted |
| 3 | <b>VACUU-BUS®</b> cable               |
| 4 | Vacuum vessel, recipient              |
| 5 | Vacuum valve                          |
| 6 | Vacuum hose                           |
| 7 | Diaphragm pump, vacuum pump           |



⇒ Install the controller as close as possible to the process in order to optimize vacuum control.

## 4.2 Connection

### 4.2.1 Electrical connection

#### NOTICE

**The CE/UKCA mark and a cTÜVus mark (see rating plate) may be voided if not using a VACUUBRAND power supply.**

- ⇒ Use a VACUUBRAND wall power supply plug or another VACUUBRAND peripheral device (e. g., Chemistry pumping unit PC 3001 VARIO<sup>pro</sup>) to provide the supply voltage.
- ⇒ If the supply voltage is not provided by VACUUBRAND wall power supply plug or any other VACUUBRAND peripheral device (e. g., Chemistry pumping unit PC 3001 VARIO<sup>pro</sup>), the power supply must provide a stabilized 24 V DC voltage which must not provide more than 6.25 A even in case of failure.
- ⇒ If using additional overcurrent protection devices (e. g., fuses), these protection devices must interrupt the supply voltage at a maximum current of 8.4 A after 120 s at the latest.

#### Wall power supply kit\*

Power supply kit for  
CVC 3000

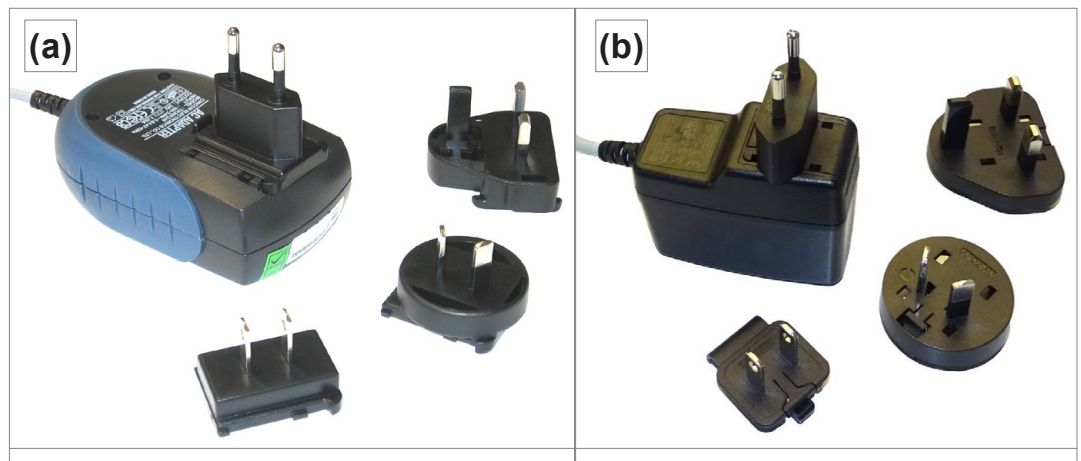

\* Short-circuit-proofed multi-voltage power supply with integrated overload protection and changeable mains plugs:

(a) valid until 11/2020

(b) valid from 12/2020

#### Prepare wall power supply plug

1. Take the wall power supply kit out of the packaging.
2. Select the mains plug that fits to your mains socket.

Prepare connection

3. Connect the mains plug to the metal contacts of the wall power supply plug.
4. Slide the mains plug until it locks.

## Remove mains plug

Remove mains plug

1. Press the locking knob on top of the wall power supply plug.
2. Remove the mains plug.

Another mains plug can be fixed.

## Connect power supply to the controller

⇒ Plug female connection of the power supply cable into mains connection of the controller.

Mains connection on the rear side

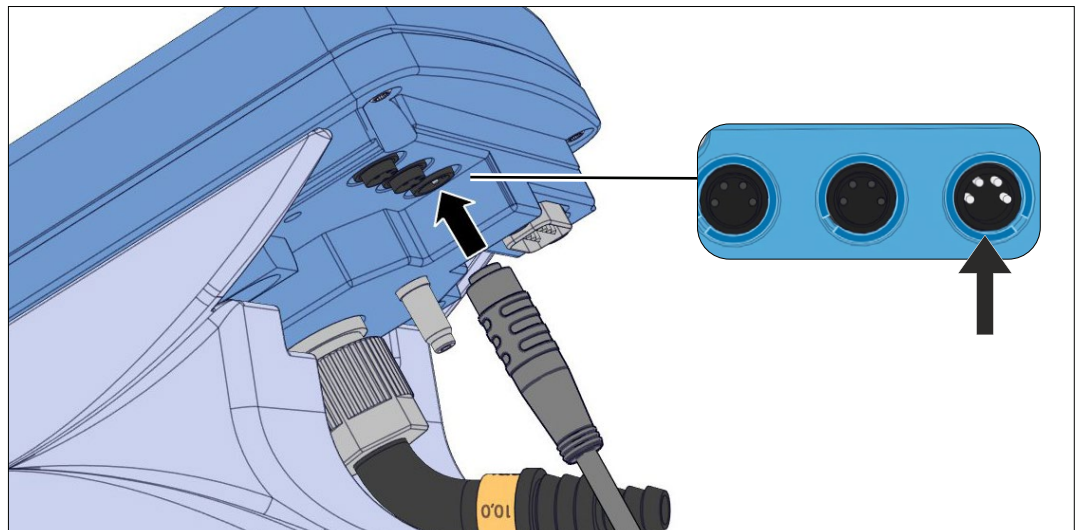

Ports with guide groove

### Consider new connection design:

For easy connection, the CVC 3000 of the newest series have a guide groove on the rear side for each port.

For connection insert the nose of the round plug into the guide groove.

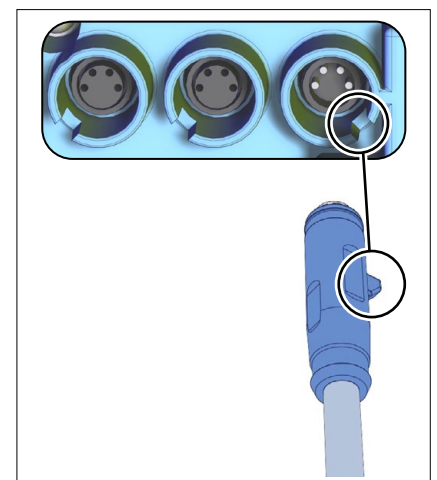

**IMPORTANT!**

- ⇒ Please install the power supply line in such a way, that no damage be caused to the cable due to sharp edges, chemicals or hot surfaces.

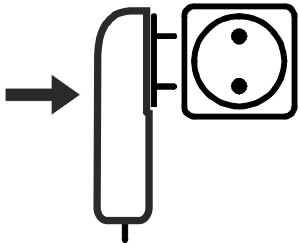
**Connect to mains**

- ⇒ Plug the wall power supply into the mains socket.

**4.2.2 Vacuum connection****NOTICE****Flexible vacuum hoses can contract because of evacuation.**

- ⇒ Fix vacuum hose at the connections.
- ⇒ Fix connected components.
- ⇒ Measure and trim the vacuum hose to a length that cares for the maximum shrinkage.

**Possible damages to parts which are in contact with process media.**

Residuals of aggressive or condensing media can cause damages to the controller or its inner parts.

- ⇒ Prevent that damaging process media can get into the controller.

Filters will compromise measurement and control.

**Connect vacuum line**

- ⇒ Connect the vacuum line gas-tight to the vacuum port of the controller;  
→ see also *Connection examples on page 32*.

**IMPORTANT!**

- ⇒ Only use a vacuum hose that is sufficient for the purpose and which provides enough stability.
- ⇒ Use hose tubes as short as possible.
- ⇒ Maximum admissible pressure at vacuum sensor:  
1,5 bar/ 750 Torr (absolute).
- ⇒ Observe the maximum measuring limit of the controller, approximately 1060 mbar (795 Torr).

**Connection examples**

Depending on design and installation the controller provides several options for connection to the vacuum system.

Table top version

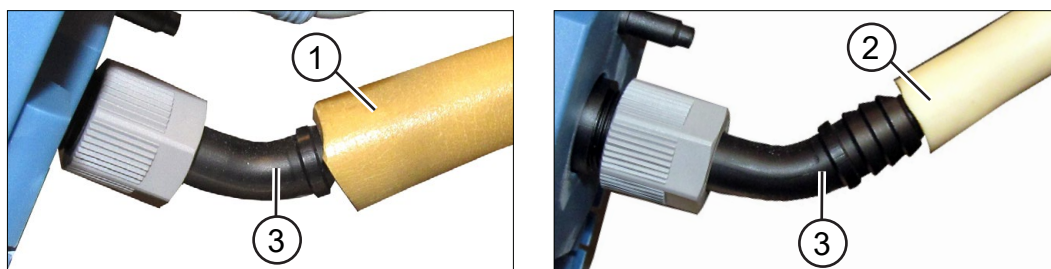

- Flexible caoutchouc hose (1) or (2), directly plugged on the hose nozzle (3).

Direct installation

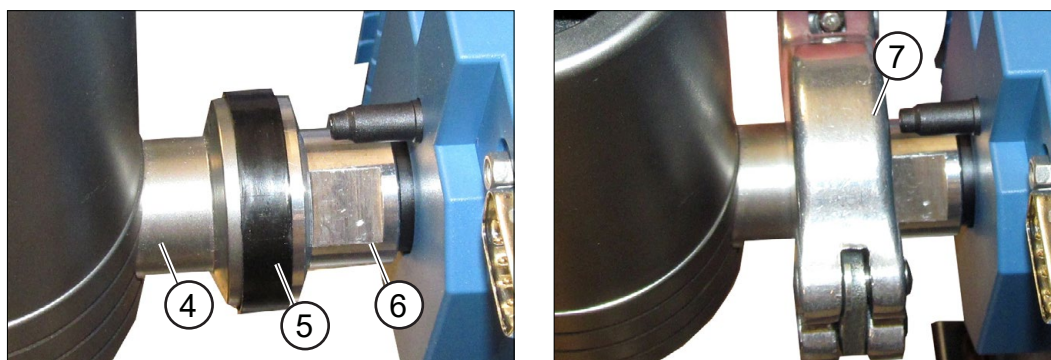

- Flange connection (4) at vacuum chamber with sealing ring (5) and small flange (6) screwed to CVC 3000 fixed with clamping ring (7).

Built-in version (front mounting)

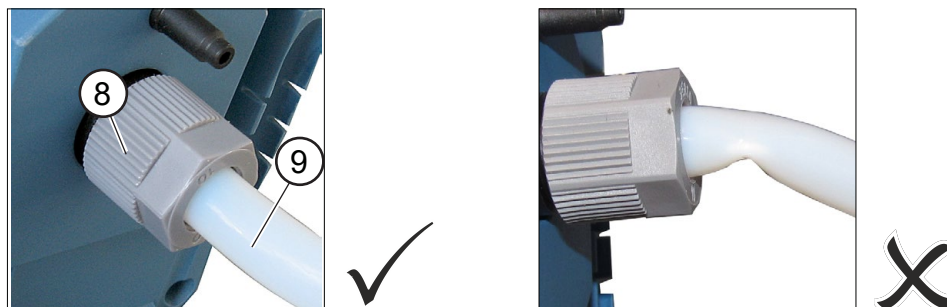

- Vacuum hose made of PTFE (9) – plugged on hose nipple, fixed with union nut (8).

**IMPORTANT!**

With built-in controller the vacuum port is not visible. The vacuum hose may not be kinked.

- ⇒ Make sure there is sufficient space inside the housing, or
- ⇒ use a stable, curved hose nozzle for connection.



### 4.2.3 VACUU-BUS®

Meaning and functioning

**VACUU-BUS®** is a system for communication to peripheral accessories which can be directly connected to the controller. These accessory components are self-configuring by switching on the controller. All **VACUU-BUS®** components are compatible to the controller.

Two ports on the rear of the controller are for connection of **VACUU-BUS®** components. These plug-and-socket connections and Y adapters make it possible to connect up to 32 accessory components.

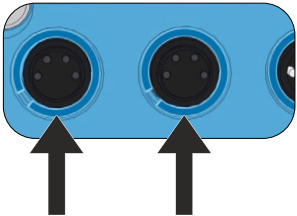

#### VACUU-BUS® principle

→ Example  
Principal sketch

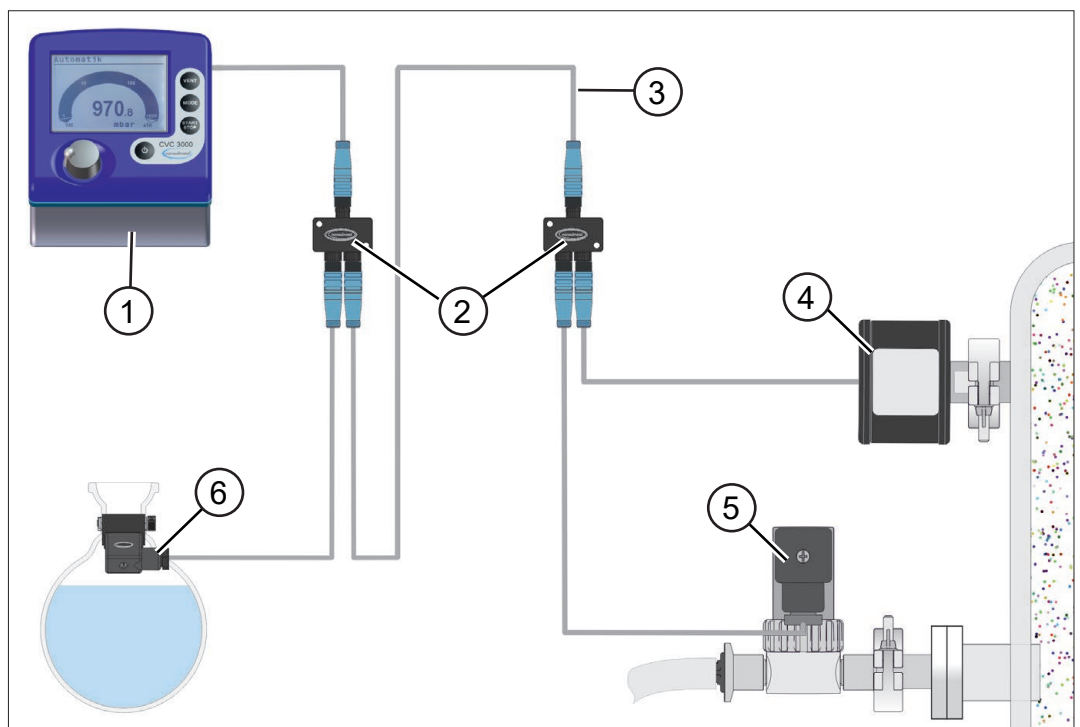

VACUU-BUS®  
components

- |                   |                                |
|-------------------|--------------------------------|
| 1 CVC 3000        | 4 Vacuum sensor VSK            |
| 2 Y adapter       | 5 Vacuum valve (In-line valve) |
| 3 Extension cable | 6 Level sensor                 |

#### IMPORTANT!

⇒ When connecting multiple, identical **VACUU-BUS®** components, e. g., 3 external vacuum sensors VSK, those first need to be assigned different addresses, in order to avoid communication faults.

**VACUU·BUS® components**

VACUU·BUS®  
accessories  
(Option)

|  |  |          |
|--|--|----------|
| <b>Vacuum sensor</b>                                   | VSK 3000   | 20640530 |
|  | VSP 3000   | 20636163 |
|  | VACUU·SELECT Sensor  | 20700020 |
|  | VACUU·SELECT Sensor<br>without venting valve   | 20700021 |
| <b>Vacuum gauge</b>                                    | VACUU·VIEW   | 20683220 |
|  | VACUU·VIEW extended  | 20683210 |
| <b>Vacuum valve</b><br><i>(In-line valve)</i>          | VV-B 6   | 20674290 |
|  | VV-B 6C  | 20674291 |
|  | VV-B 15C, KF 16  | 20674210 |
|  | VV-B 15C, KF 25  | 20674215 |
| <b>Coolant valve</b>                                   | VKW-B  | 20674220 |
| <b>Air admittance valve</b>                            | VBM-B  | 20674217 |
| <b>Vacuum module for<br/>switching vacuum<br/>pump</b> | VMS-B  | 20676030 |
| <b>...-I/O module</b>                                  | Digital...<br>IN: 5-75 VDC / OUT: 60 VDC (2,5 A)<br>IN: 5-50 VAC / OUT: 40 VAC (2,5 A) | 20636228 |
|  | Analog...<br>IN: 0-10 V / OUT: 0-10 V  | 20636229 |
|  | Analog...<br>IN: 4-20 mA / OUT: 0-10 V   | 20635425 |
| <b>Level sensor</b>                                    | 500 ml round bottom flask  | 20699908 |
| Extension cable  | VACUU·BUS® 2 m   | 20612552 |
|  | VACUU·BUS® 10 m  | 22618493 |
| Y adapter  | VACUU·BUS®   | 20636656 |

## 5 Operating and display elements

### 5.1 Operating elements

The operating elements are located on the controller front.  
controller figure



→ see chapter 3.1 *Vacuum controller CVC 3000 on page 21*

#### 5.1.1 Selection knob

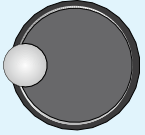
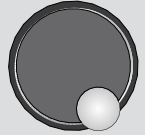
The selection knob of the controller is a combination of rotary knob and push-button.

|                      | Selection knob  | Meaning  |
|----------------------|---|--|
| Press selection knob |    | <p>Press – <b>Selection knob</b> =</p> <ul style="list-style-type: none"> <li>▶ Call up menu or function.</li> <li>▶ Exit menu or function.</li> <li>▶ Confirm and store setting or selection.</li> <li>▶ Step to next menu, function or content.</li> <li>▶ Call up <b>Configuration</b> menu while booting.</li> </ul> |
| Turn selection knob  |  | <p>Turn – <b>Selection knob</b> =</p> <ul style="list-style-type: none"> <li>▶ Select menu, navigation function.</li> <li>▶ Value setting – increase/decrease.</li> <li>▶ Adapt set vacuum (in mode Vac control).</li> </ul>   |

#### 5.1.2 Control panel

|                    | Key   | Meaning   |
|--------------------|---|---|
| Control panel keys |  | <p><b>On/Off</b></p> <ul style="list-style-type: none"> <li>▶ Switch on/off controller.</li> </ul>  |
|                    |  | <p><b>Start/Stop</b></p> <ul style="list-style-type: none"> <li>▶ Start/stop vacuum control.</li> <li>▶ Confirm completed program when clock icon blinks.</li> <li>▶ Confirm error and status indications.</li> </ul>   |
|                    |  | <p><b>VENT</b> – system venting;</p> <ul style="list-style-type: none"> <li>▶ Keystroke &lt; 2 sec = momentarily venting, control continues.</li> <li>▶ Keystroke &gt; 2 sec = venting to atmospheric pressure (max. 1050 mbar/787 Torr), control stops.</li> <li>▶ Keystroke while venting = venting stops.</li> </ul> |

Control panel keys

 **Mode** – Select operation mode

- ▶ With stopped operation: Mode menu for selecting the operation mode.

**Mode** – Change function/mode

- ▶ During running operation: To switch from *Pump down* to *Vac control* and further to *Auto mode*.
- ▶ During running operation: To switch between *Auto mode* and *Vac control*.

### 5.1.3 Key combinations





Menus and functions that are not intended for everyday use, can only be accessed through key combinations.

**NOTICE**

**Wrong key combinations can lead to faulty settings.**

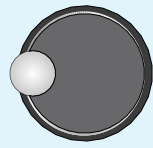
⇒ First push and hold the key which must be hold and pressed, only then push the combination key shortly.

Key combinations  
(key shortcuts)

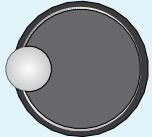
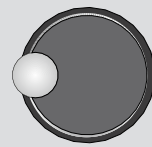
| Combination   | Meaning   |
|---|---|
|  +  | Press and hold <i>Selection knob</i> + Press <i>On/Off</i> =<br><b>Only when the controller is switched off</b> |
|  +  | Press and hold <i>VENT</i> + Press <i>On/Off</i> =<br>▶ Call up menu <i>Function</i>                            |
|  +  | Press and hold <i>Mode</i> + press <i>Selection knob</i> =<br><b>Only in <i>Function</i> menu</b>               |
|    | Press and hold <i>Selection knob</i> + turn it =<br>▶ Quick adaption set vacuum. (in mode <i>Vac control</i> )  |
|   | <b>Only in combination with VARIO®</b>  |
|   | ▶ Quick adaption motor speed high/low (in mode <i>Pump down</i> )   |

## 5.2 Display and user interface

After booting the pressure display appears, including **Bar graphic** and preset operation mode.

### 5.2.1 Pressure display

→ Example  
Display after  
switching on  
CVC 3000

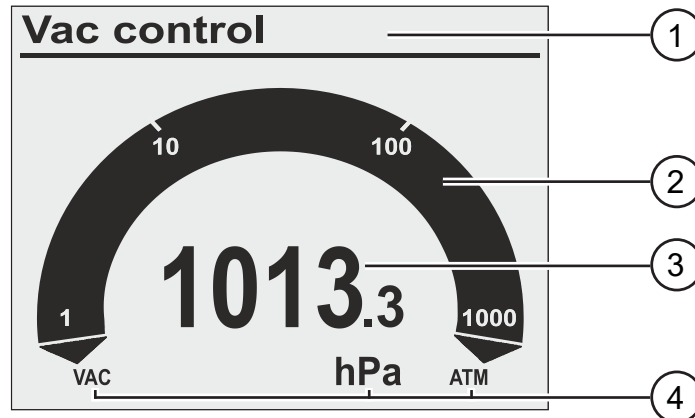

Meaning

|                                    |  |
|------------------------------------|--|
| <b>1 Title bar (or status bar)</b> | <ul style="list-style-type: none"> <li>▶ Operation mode - <i>Mode</i></li> <li>▶ Pump down</li> <li>▶ Vac control</li> <li>▶ Auto mode</li> <li>▶ Program</li> <li>▶ VACUULAN</li> </ul> |
| <b>Process time</b>                | ▶ hh:mm:ss<br>(only displayed with running process)  |
| <b>2 Bar graphic</b>               | ▶ Graphical display of actual pressure   |
| <b>3 Numerical value</b>           | ▶ Actual pressure = digital pressure display   |
| <b>4 VAC</b>                       | ▶ Vacuum   |
| <b>mbar</b>                        | ▶ Pressure unit according to pre-setting<br>(mbar, Torr, hPa)  |
| <b>ATM</b>                         | ▶ Atmospheric pressure   |

### 5.2.2 Display icons

When vacuum control has started additional icons appear on the display.







#### When starting operation

Display symbols during operation

| Icon  | Meaning   |
|---|---|
|  | Vacuum control is running (animation)           |
| <b>00:00:00</b>   | Process time; runtime vacuum control (hh:mm:ss) |

#### Active component

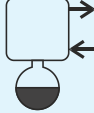
Icons for active components









| Icon  | Meaning   |
|---|---|
|    | Pump is running; in combination with percentage sign = motor speed (only for VARIO systems)     |
|  | Venting* valve is active, i. e. open (VENT);<br>Flashing cycle: continuous venting switched on. |
|  | Coolant valve switched on, open   |
|  | In-line valve switched on, open   |
|  | Emission condenser (Peltronic) connected  |
|  | Level sensor activated<br>(only when level sensor is connected)                                 |

\* also named air admittance valve

The icon of a connected component is displayed as long as the component is running.



**Status display while operation is running**

Icons for control status

| Icon  | Meaning   |
|---|---|
|    | Pump down – continuous pumping  |
|    | Pump down: lower pressure limit reached<br>VACUU·LAN: pump down to set pressure<br>Vac control: for 2-point control – pump down to set pressure                   |
|    | VACUU·LAN: pressure increase to switch on pressure<br>Vac control: preset maximum exceeded  |
|    | VARIO control: pump down to set point.<br>Auto mode: pump down and boiling point detection within the preset time interval regarding changing process conditions. |
|    | VARIO control: reaches and tracks boiling point. The next program step starts when the programmed pressure has been reached or the preset time has elapsed.       |
|   | 2-point control: pressure in hysteresis, pump switched on   |
|  | 2-point control: pressure in hysteresis, pump switched off  |
|  | Turbo mode switched on (for VARIO® pump in combination with turbomolecular pump)  |

**Additional information**

Information icons

| Icon   | Meaning   |
|--|---|
|             | Clock<br>- Program completed*<br>- Mode VACUU·LAN: delay time elapses |
|             | Lock – operation locked   |
| <b>HI</b>  | HI mode for Pump down = optimum speed for the respective pressure.    |
| <b>..%</b>   | Percentage value for Pump down motor speed.                           |
| <b>100</b>  | Set value for Vac control.  |

\* The clock icon keeps flashing until the **Start/Stop** button has been pressed to acknowledge the end of program.



**Fault indication (warning symbol)**

Error display

| Icon  | Meaning            |
|---|--------------------|
|  | Flashing: warning! |

**When device connected to SUB-D (Option)**

Active connection to RS232 port



| Icon  | Meaning  |
|---|--|
|  | Controller in remote mode; controller only controllable via connected PC or Notebook, local operation disabled.                          |
|  | VACUU·CONTROL®-adapter connected; Remote <b>and</b> local operation possible. → Remote operation via end device (e. g., PC, Smartphone). |

**5.2.3 Signal sounds (warning beep)**

Setting *Sound On* in menu **Configuration/Display** is required to hear the audio signals.

**Meaning signal sound**

Audio signal (beep)

| Audio signal   | Meaning  |
|--|--|
| 1x )))  | Short beep for each keystroke.   |
| 2x )))  | Audio warning for error indication. In short intervals a number of warning beeps are to be heard. This Audio warning is active until error clearance or reset. |



Error messages are indicated by differing numbers of beeps (audio warning).

For the list of possible warning beeps → see chapter **8.1 Error display on page 69**.



### 5.2.4 Menu display in general

The controller includes several menus and submenus, e. g., **Configuration**, **Function**, **Display...**

#### Submenu

→ Example  
Submenu  
Configuration

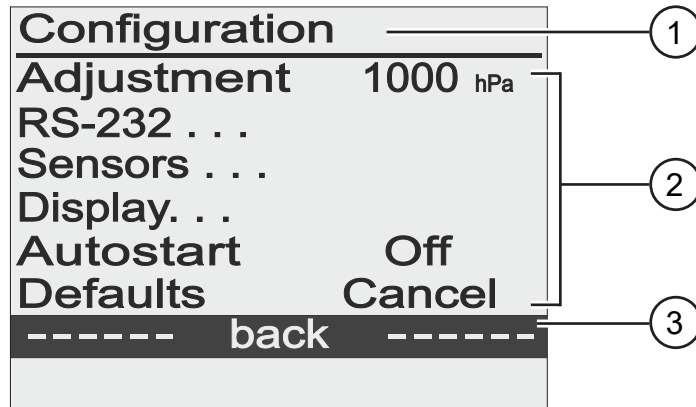

Meaning

|                         |  |
|-------------------------|--|
| <b>1 Titel bar</b>      | ▶ Menu name  |
| <b>2 Menu interface</b> | ▶ Selectable functions or submenus<br>(on the right side of the display)<br>▶ Adaptable value or<br>▶ selectable content |
| <b>3 Back (return)</b>  | ▶ Call-up previous menu or<br>▶ previous display   |



For detailed descriptions about individual menus,  
→ see chapter **7.1 Operation menus**.

### 5.3 Handling CVC 3000

Handling and Operation

The handling of the controller is menu-driven. Menus are accessed via push buttons on the control panel or via key combinations. Use the selection knob to select function or menu.

Operating steps and actions are displayed by an illustration, which is complemented by action symbols.

→ see chapter 1.2.2 *Symbols and icons*.

#### Navigation

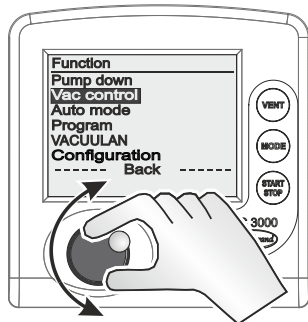

Turn selection knob to select a menu by shifting the bar marking.

→ **bar marking** up/down.

#### Submenus



Submenus are highlighted with points.

#### Selection

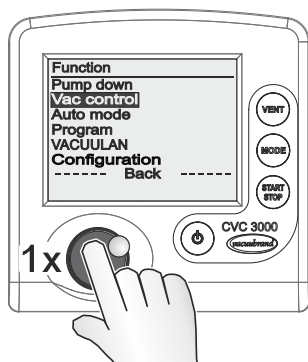

Press selection knob to confirm selection.

**Input (data entry)**

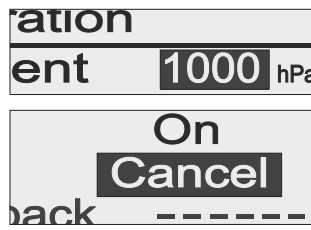

Changeable values are positioned on the right side in the display.

Text on the right side accords to content selection like in a drop down list.

Exception: menu **Program**, in this menu data and value are editable.

**Example: enable entry and edit**

1. Select the required line and press selection knob.
  - Marking jumps to the input field.
  - Input/Content selection enabled.
2. Turn the selection knob.
  - Value/Content changes.
3. Adapt the numeric value within the specified min./max. range or select the required function out of the available content.
4. Confirm input/selection by pressing the selection knob.
  - Value is stored or
  - selected function starts.

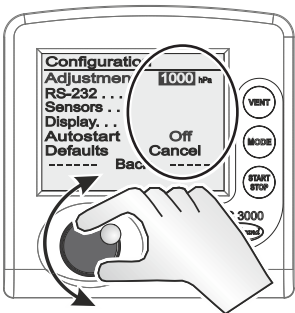

**Back (return)**

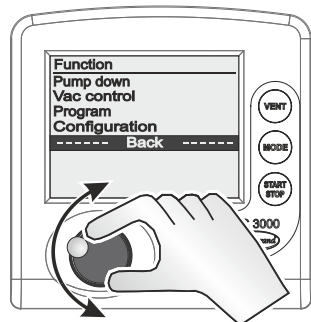

Place the bar marking on line **back** and press the selection knob to return to previous menu, display or to pressure display.



In submenu **Sensors** the display returns to previous menu only after the selection of a sensor.



## 6 Operation

### 6.1 Switch-on/-off controller

#### Switch-on

Switch on CVC 3000

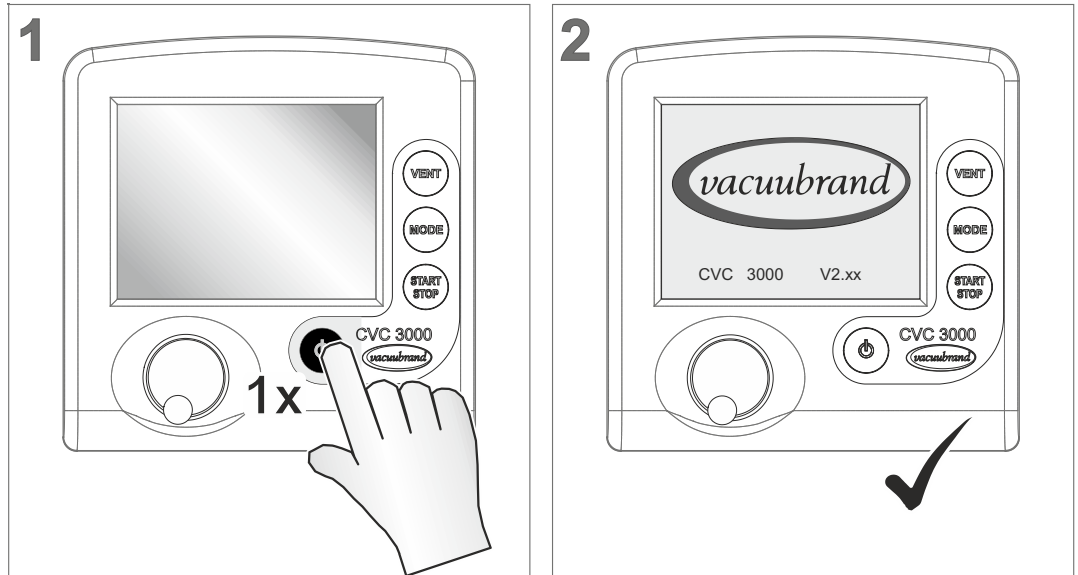

- ☑ Initial screen: company logo and firmware version, for approximately 2 seconds.
- ☑ Pressure graphic is displayed.

#### Switch-off

Switch-off CVC 3000 ⇒ Press key *On/Off*

- ☑ Controller switched off (display off).

## 6.2 Select language and pressure unit

Select language and pressure unit

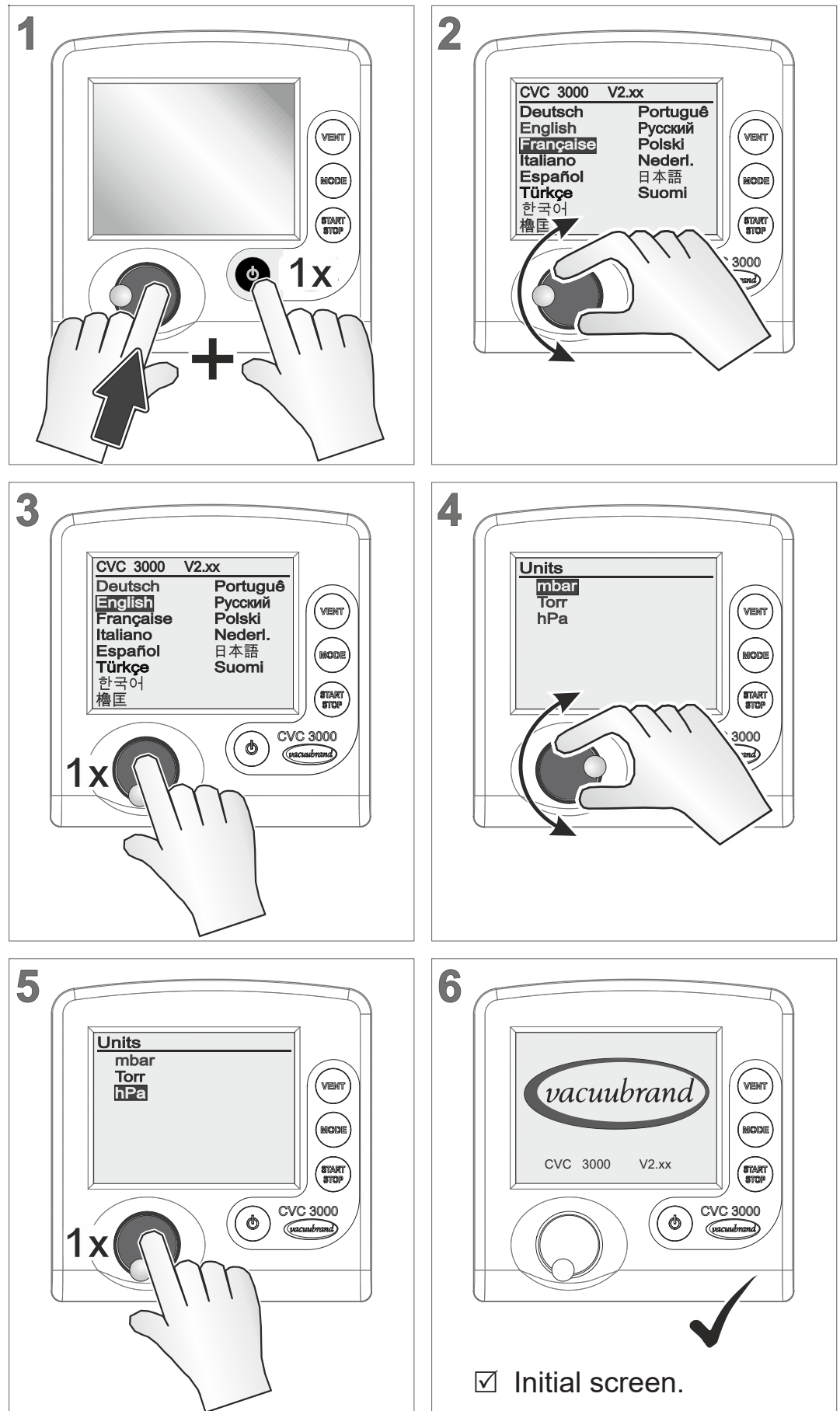

### 6.3 Mode – Operation mode



The controller is supplied with several operating modes. Only when the controlling process is stopped it is possible to select an operation mode.

#### 6.3.1 Select operation mode

→ Example  
Call-up Mode menu

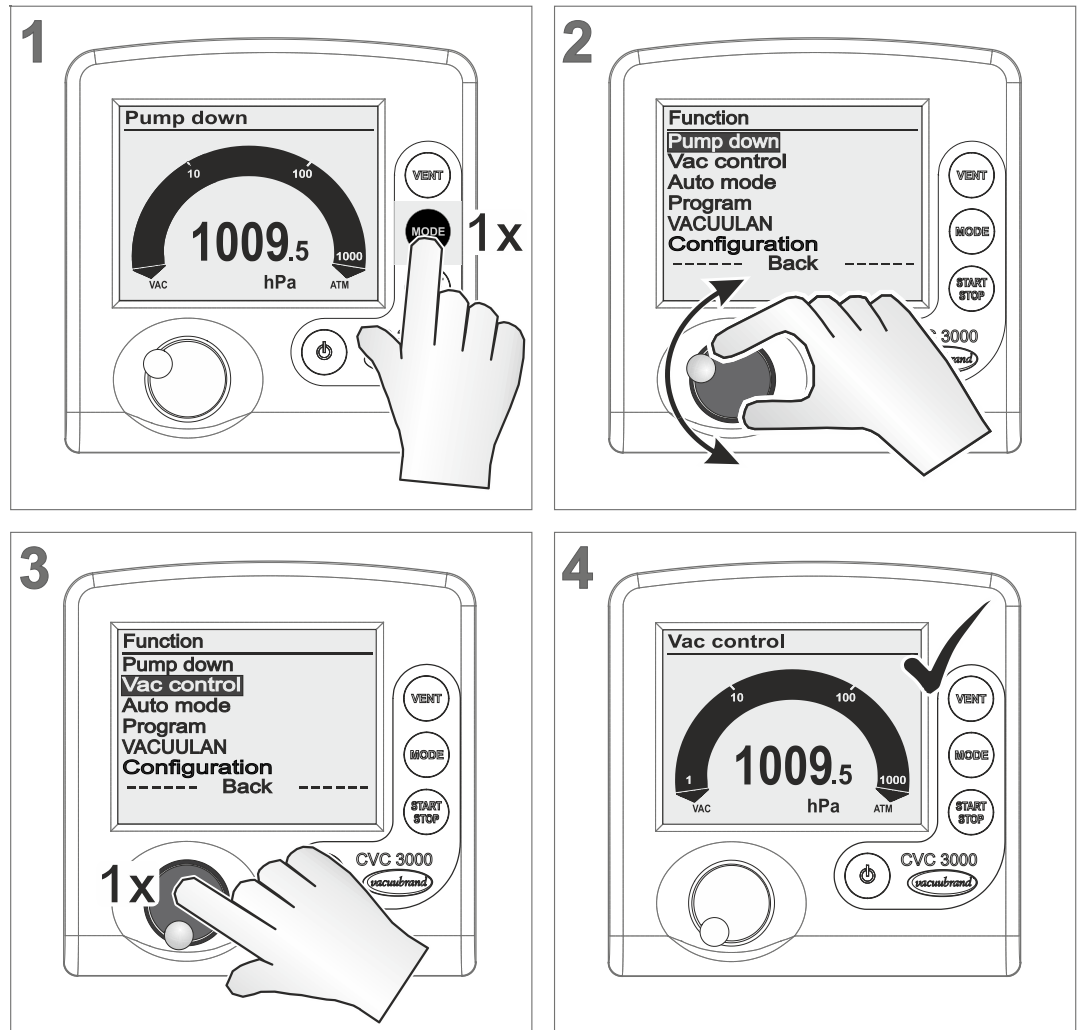

Title bar shows the selected operation mode (**Mode**).



Select any other operation mode in the same way as described above for **Vac control**.  
After 20 seconds without action, the display will return automatically to pressure display.

### 6.3.2 Mode menu

#### Mode menu display

→ Example  
Menu description

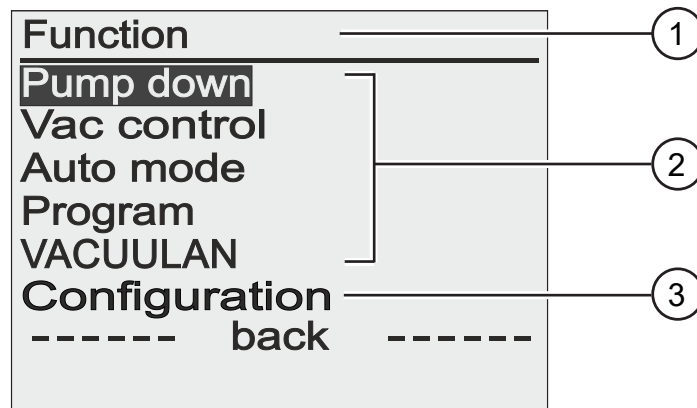

Meaning and  
operation modes

|   |
|---|
| <b>1 Title bar menu name</b>  |
| <b>2 Selectable operation modes</b>   |
| <p><b>Pump down</b></p> <ul style="list-style-type: none"> <li>▶ Continuous pump down or</li> <li>▶ Pump down with pressure and time presetting.</li> <li>▶ <b>VARIO®</b>: pump down with adjustable motor speed (pumping speed) and continuous speed control.</li> </ul>                       |
| <p><b>Vac control</b></p> <ul style="list-style-type: none"> <li>▶ Control to a preset vacuum value.</li> </ul>   |
| <p><b>Auto mode</b></p> <ul style="list-style-type: none"> <li>▶ Controlling a <b>VARIO®</b> pump in <i>Auto mode</i>: Detect and track boiling point automatically, exact vacuum adaption even with flexible process conditions.</li> </ul> <p><i>Listed only with <b>VARIO®</b> pump.</i></p> |
| <p><b>Program</b></p> <ul style="list-style-type: none"> <li>▶ Load, edit and/or store program.</li> <li>▶ max. 10 programs with pressure and time presetting.</li> </ul>   |
| <p><b>VACUULAN</b></p> <ul style="list-style-type: none"> <li>▶ Control of the vacuum pump according to demand, optimized for vacuum networks.</li> </ul> <p><i>Listed only with <b>VARIO®</b> pump or <b>VMS</b> module, e. g., for pump control.</i></p>                                      |
| <b>3 Menu Configuration</b>   |

⇒ Select the mode suitable for vacuum apparatus and planned process.



## 6.4 Start controlling



Start vacuum controlling after selecting the required operation mode. The controller works in delivery status with the default settings of the factory setting.

### Start controlling

→ Example  
Start CVC 3000

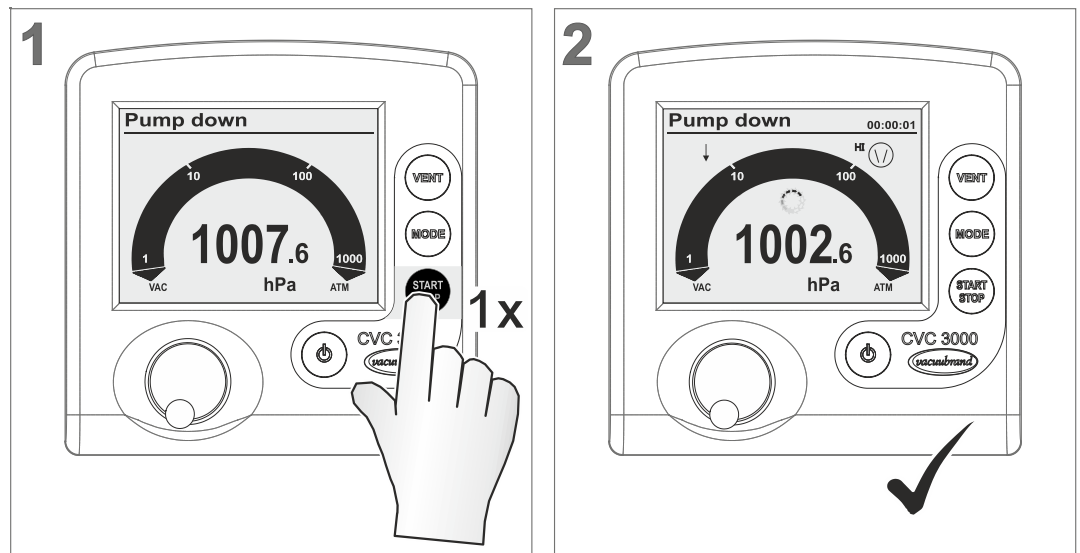

- Controller starts.
- Icons are displayed.

## 6.5 Control during operation

### 6.5.1 Venting (VENT)

|   |               |
|---|---------------|
|   | <b>DANGER</b> |
| <p><b>Danger of explosion when venting with air by forming of explosive mixtures.</b></p> <p>Depending on the process venting can cause formation explosive mixtures.</p> <ul style="list-style-type: none"> <li>⇒ Never vent processes with air which can form explosive mixtures.</li> <li>⇒ If necessary vent with inert gas (max. 1.2 bar absolute).</li> </ul> |               |

#### **IMPORTANT!**

Certain processes may cause overpressure.



## Venting

The **VENT** button is used to vent the system. A short click on this button will momentarily vent the system as the process continues. Holding the **VENT** key for longer than 2 seconds will cause the system to be vented to atmospheric pressure and the pump will stop running; max. 1060 mbar (795 Torr). Continuous venting stops when pressing **VENT** key again.

### Momentarily venting

→ Example  
Momentarily venting

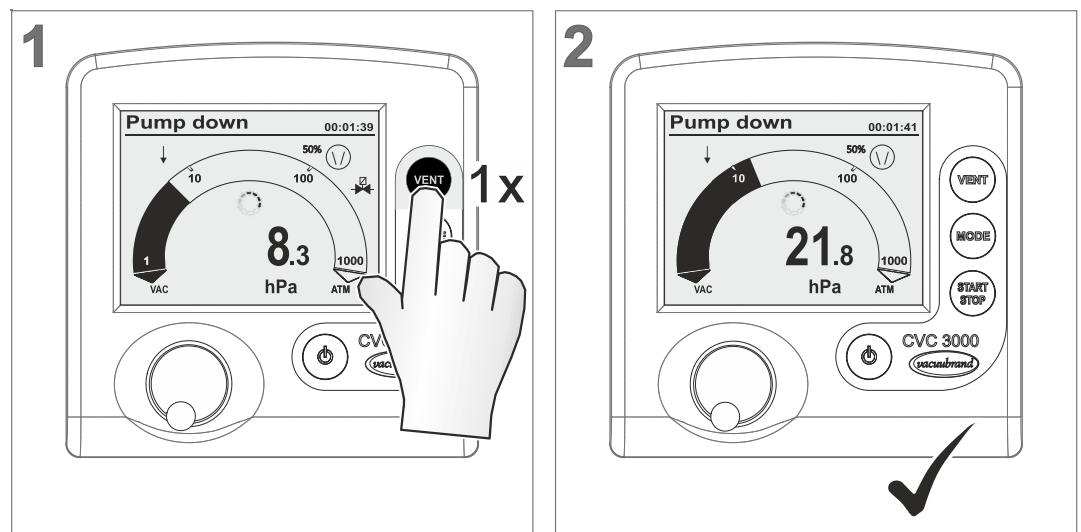

- ☑ Venting impulse, venting valve respectively air admittance valve opens momentarily → short-term pressure increase.

### Continuous venting

→ Example  
Continuous venting

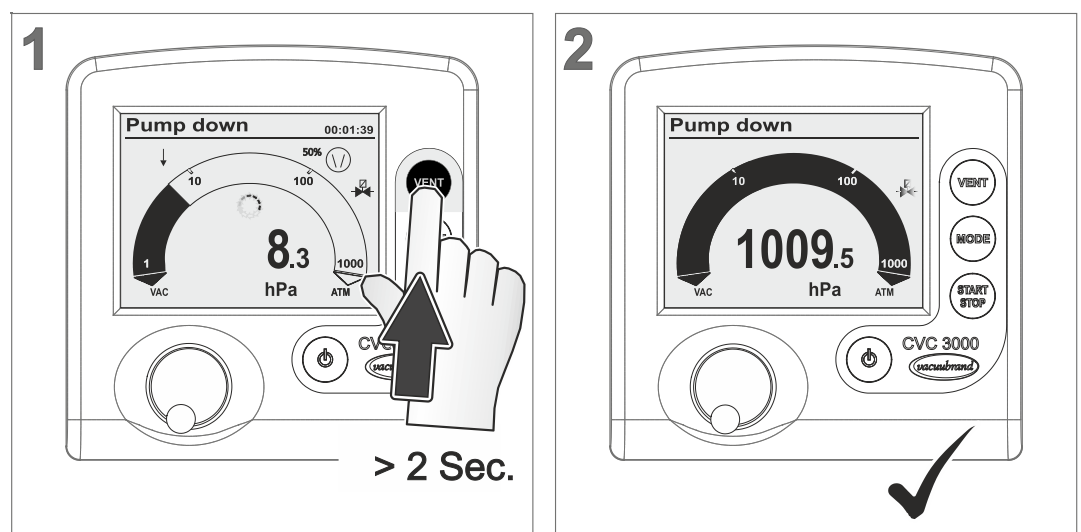

- ☑ Icon for venting valve is flashing,
- ☑ Venting valve opens → continuous pressure increase until atmospheric pressure → venting valve closes.
- ☑ Controller stops.

### 6.5.2 Change operation mode



During running operation the operation mode can be switched between *Pump down*, *Vac control* and *Auto mode*<sup>1</sup> by pressing **Mode** key.

#### Switch mode during running operation

→ Examples  
Switch mode

Pump down  
↓  
Vac control

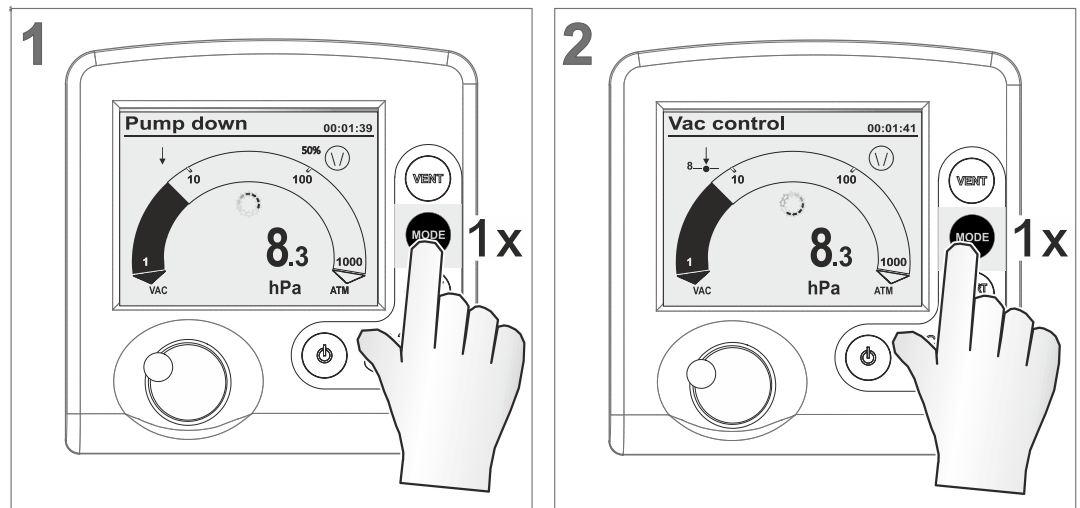

☑ Operation mode switched to *Vac control*.

↓  
Auto mode  
↓  
Vac control  
with **VARIO**®

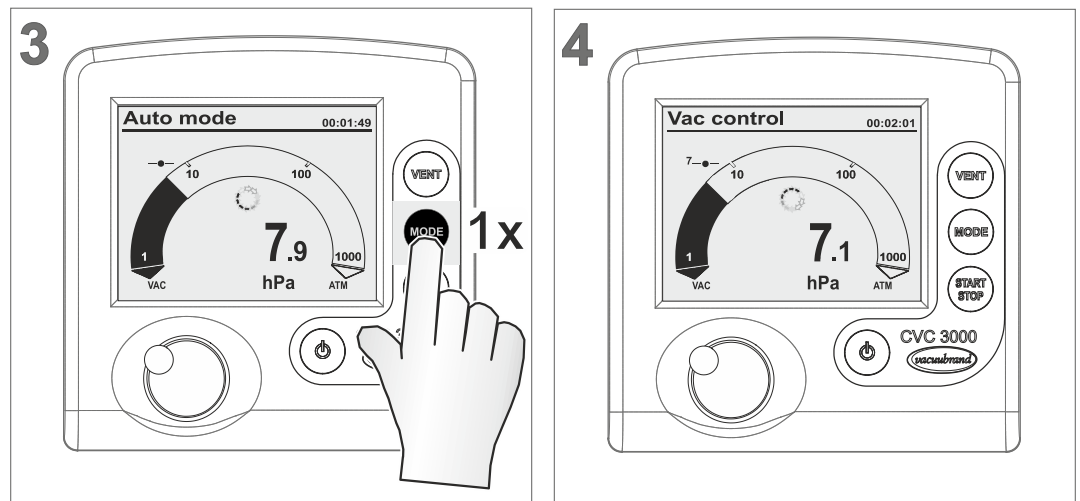

☑ Operation mode switched from *Vac control* to *Auto mode*<sup>1</sup> and back.

☑ Set vacuum adopted from last status in *Auto mode*<sup>1</sup>.

<sup>1</sup> -> Only when connected to **VARIO**® pump.

Switch back from **Vac control** to **Pump down**.

Switch back to primary mode

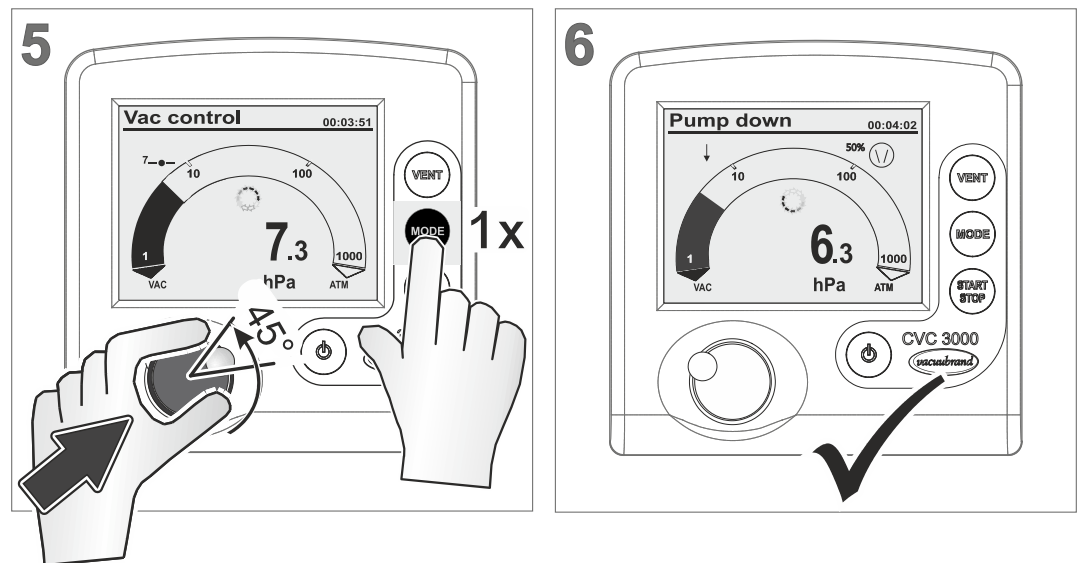

Title bar displays **Pump down**.

## Typical applications

### **Pump down** → **Vac control**:

**Semiautomatic distillation.** Recommended for applications for which the process vacuum is still to be determined. Firstly the vacuum pump is pumping down rapidly in mode **Pump down**. As soon as the required process vacuum has been reached, e. g., boiling vacuum, this vacuum can be maintained by switching to **Vac control**. The actual pressure is adopted as the required set vacuum.

### **Auto mode** ⇔ **Vac control**:

With a connected **VARIO**® pump a controller working in **Auto mode** will detect and track the boiling point automatically. The vacuum will be adapted continuously to the process.

If a particular process vacuum is required, the mode can be switched back again to **Vac control**.



**Switching the mode during operation via **Mode** key works only temporarily. After stopping the controller switches back to its primary mode.**

### 6.5.3 Display graphic (curve)

Pressure history

In addition to the bar graphic of the pressure display the display can be switched to a diagram named **Graphic** which shows a pressure vs. time curve.

That **Graphic** curve will only be displayed while operation is running. With each start the recording restarts.

#### Call up graphic

→ Example  
Call up pressure  
history display

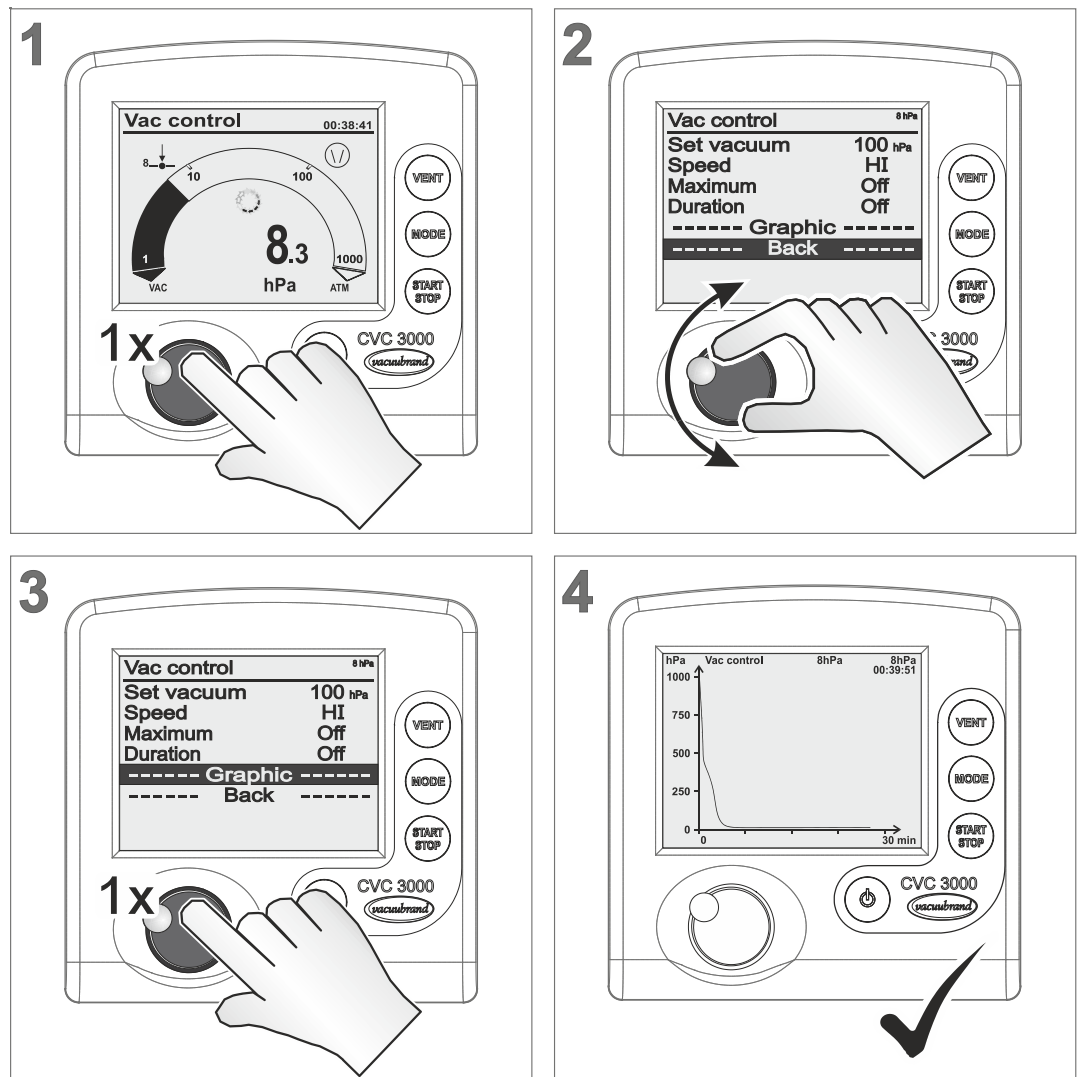

- ☑ **Graphic** menu is displayed with the pressure curve of the actual process.



To call up **Graphic** with pressure history for other operation modes, do like described above.

### Graphic menu

Description pressure history display

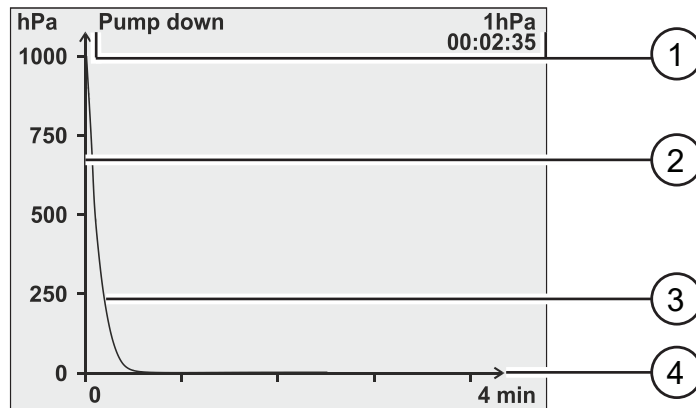

Meaning

- 1 Header**
  - ▶ Active operation mode.
  - ▶ Vacuum set point; for *Vac control* or *Auto mode*.
  - ▶ Actual vacuum value (actual pressure).
  - ▶ Elapsed process time.
- 2 Axis – pressure**
  - ▶ Unit according to pre-settings (mbar, Torr, hPa)
- 3 Pressure graph**
  - ▶ Pressure/time progress
- 4 Axis – time**
  - ▶ Continuous, automatically scaling time (minute, hour)

### 6.5.4 Quit display graphic

#### Return to basic display

→ Example  
Switch back to  
basic display

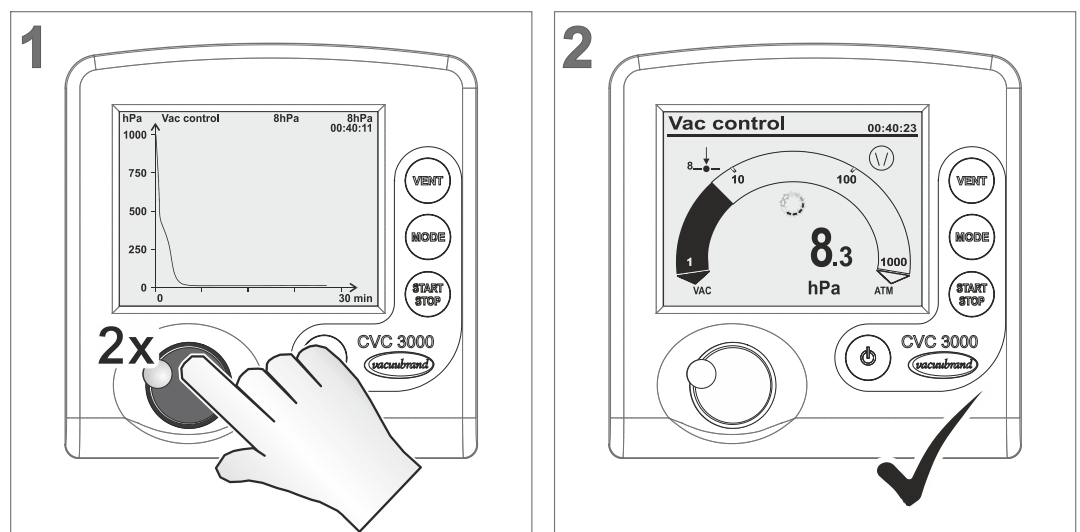

View basic display.

## 6.6 Quick adaption during operation

### 6.6.1 Set vacuum

In mode **Vac control** the set vacuum can be adapted directly during running operation.

#### Adapt set vacuum → fine tuning

1 detent = 1 pressure value (mbar, Torr, hPa)

→ Example  
Adapt set vacuum  
fine tuning

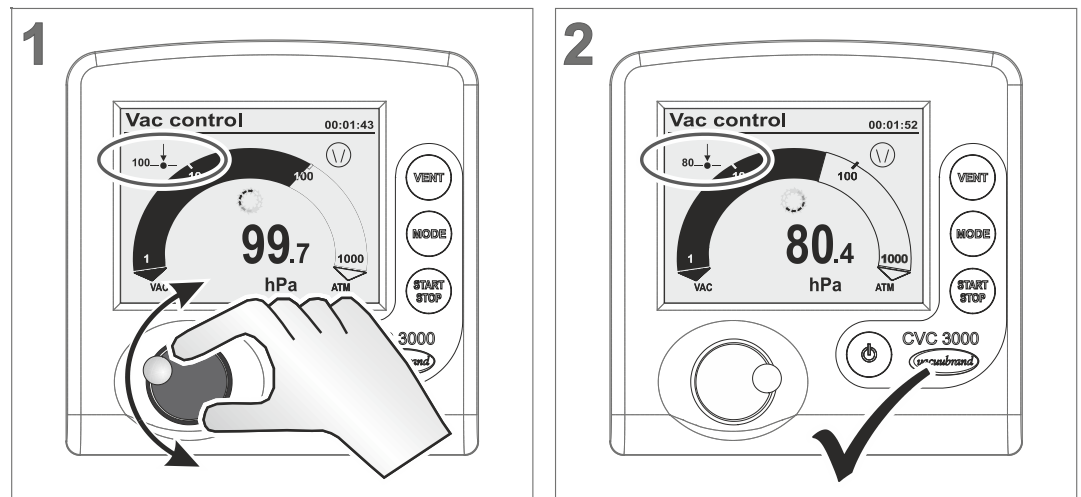

Controller controls to new set vacuum.

#### Adapt set vacuum → quick tuning

→ Example  
Adapt set vacuum  
quick tuning

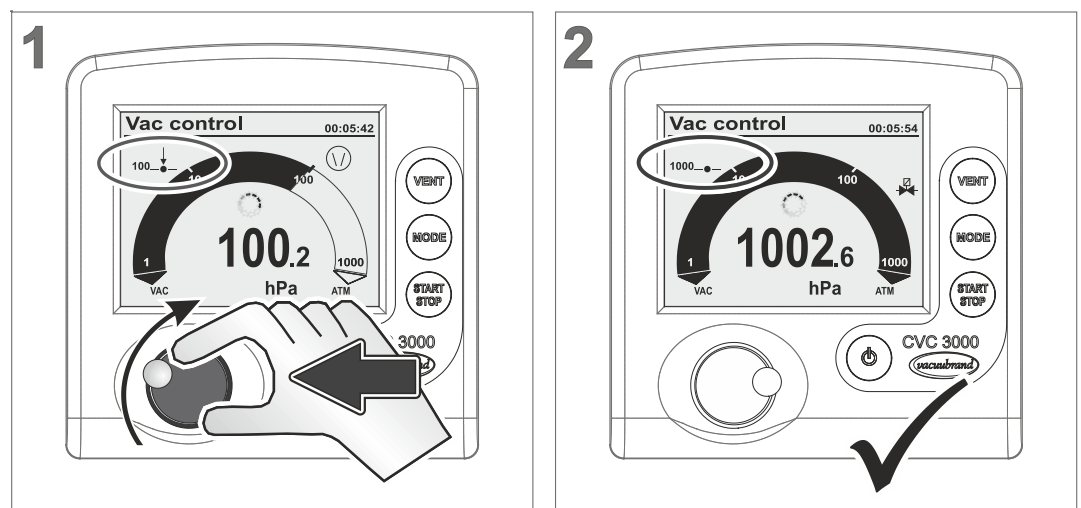

⇒ Press selection knob and turn it clockwise:  
increase set vacuum (venting).

⇒ Press selection knob and turn it counterclockwise: decrease  
set vacuum (vacuum pump on).

Controller controls to the new set vacuum which is displayed while releasing the selection knob.

### 6.6.2 Motor speed (only VARIO®)

In mode **Pump down** the motor speed of a **VARIO®** pump can be adjusted directly during running operation.

#### Pump down – adjust motor speed

→ Example  
How to change  
motor speed

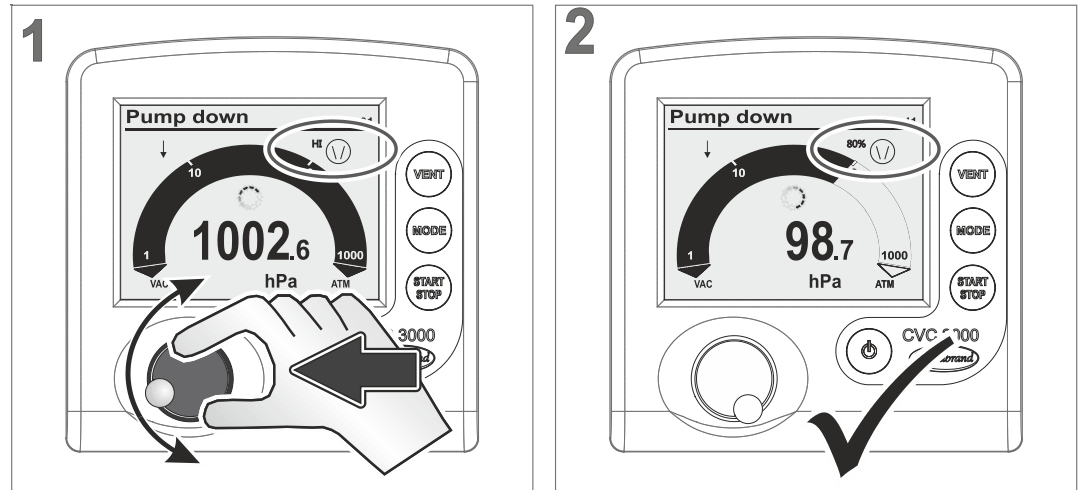

- ☑ Pump icon with percentage value.
- ☑ **VARIO®** pump runs with adjusted motor speed.

### 6.7 Stop control

#### Stop control

→ Example  
Stop CVC 3000

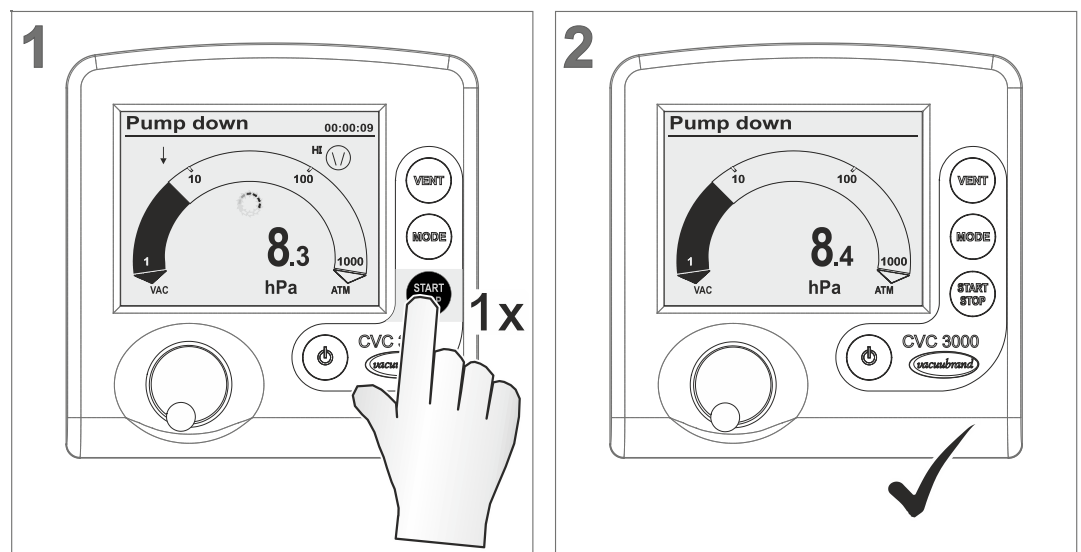

- ☑ Controller and vacuum control stops.
- ☑ Display icons switched off.



## 7 Advanced menus and operation

### 7.1 Operation menus

Optimizing operation mode

A selected operation mode can be adapted and optimized for the process through the corresponding operation menu. The settings in an operation menu include mainly: motor speed, set vacuum or time presets. Settings in operation menus are retained also after switching on/off.

Menu **Program** is for storing up to 10 individual programs, e. g., to store control settings for frequently repeated processes.

#### Call up submenu of an individual operation mode

→ Example  
Call up operation menu

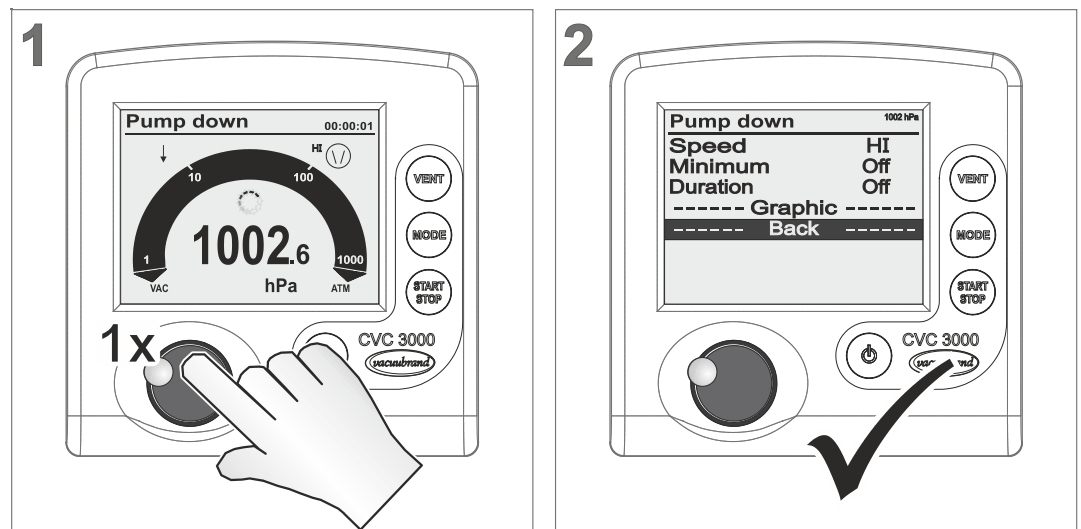

- Corresponding menu of the preset operation mode is displayed.

To call up an operation menu, press the selection knob. Adaptations are possible during a running process as well as when control is stopped.



Use operation menu to optimize vacuum control for application requirements.

## 7.1.1 Pump down

Meaning Continuous pump down with pressure and time presets.

### Menu – Pump down

→ Example  
Operation menu  
Pump down

| Pump down           |     | 1013 hPa |
|---------------------|-----|----------|
| Speed               | HI  |          |
| Minimum             | Off |          |
| Duration            | Off |          |
| ----- Graphic ----- |     |          |
| ----- Back -----    |     |          |

Parameter  
Pump down

| Parameter                      | Meaning   |
|--------------------------------|---|
| Speed (%)                      | <b>VARIO</b> ®: Speed settings for pump down.<br>Adjustment range: 1–100; HI*   |
| Minimum**<br>(mbar, Torr, hPa) | Vacuum set point; once reached, the controller switches off the vacuum pump or closes the in-line valve.<br>Adjustment range: Off; 1–1060 |
| Duration** (Min)               | Presetting process runtime from <b>Start</b> on.<br>Adjustment range: Off; 1–1440   |
| Delay (Min)                    | Delay time for an optional coolant valve.<br>Adjustment range: Off; 1–300   |

\* HI mode: optimum speed for the respective pressure.

\*\* If **Minimum** and **Duration** are set to **OFF**, pump down has to be stopped by pressing START/STOP key.

### Application example – cabinet dryer

Application example  
for Pump down

Set **Minimum** to a vacuum value below boiling pressure and the controller will switch the vacuum pump off, once the liquid has completely evaporated.

### 7.1.2 Vac control

Meaning Control to a set vacuum value.

#### Menu – Vac control

→ Example  
Operation menu  
Vac control

| Vac control         |     | 1002 hPa |
|---------------------|-----|----------|
| Set vacuum          | 100 | hPa      |
| Speed               | HI  |          |
| Maximum             | Off |          |
| Duration            | Off |          |
| ----- Graphic ----- |     |          |
| ----- Back -----    |     |          |

Parameter  
Vac control

| Parameter                       | Meaning   |
|---------------------------------|---|
| Set vacuum (mbar)               | Setting for lower vacuum level for 2-point control or precisely for <b>VARIO</b> ® pump. Adjustment range: Turbo*; 1–1060 |
| Speed (%)                       | <b>VARIO</b> ®: Speed settings for pump down. Adjustment range: 1–100; HI**   |
| Hysteresis*** (mbar, Torr, hPa) | Only for VMS or in-line valve with vacuum pump: control range for 2-point control. Adjustment range: Auto; 1–300          |
| Maximum (mbar, Torr, hPa)       | Setting for upper vacuum level. Once reached, control switches off. Adjustment range: Off; 1–1060                         |
| Duration (Min)                  | Presetting process runtime from <b>Start</b> on. Adjustment range: Off; 1–1440  |
| Delay (Min)                     | Delay time for an optional coolant valve. Adjustment range: Off; 1–300  |

\* Turbo mode: auto-adapting vacuum control for best ultimate vacuum. Best backing pressure for operation with a turbomolecular pump.

\*\* HI mode: optimum speed for the respective pressure.

\*\*\* VARIO pumps work without hysteresis.

#### Application example – filtration

Application example  
for Vac control

Set the set vacuum higher than the boiling pressure of the liquid and set **Maximum** value even a little bit higher. If the filter runs dry or if the filter is fractured, the pressure will increase and the control will be stopped automatically.

### Hysteresis values Auto

Factory settings  
Hysteresis

|                   |   |    |    |    |     |     |     |     |     |      |
|-------------------|---|----|----|----|-----|-----|-----|-----|-----|------|
| Set vacuum (mbar) | 5 | 10 | 50 | 80 | 100 | 200 | 500 | 700 | 900 | 1000 |
| Hysteresis (mbar) | 2 | 2  | 5  | 8  | 9   | 17  | 40  | 55  | 71  | 78   |

### 7.1.3 Auto mode (only valid for VARIO® pump)

Meaning Automatic detection and tracking of boiling point, unaffected by varying process conditions.

#### Menu – Auto mode

→ Example  
Operation menu  
Auto mode

|                     |        |         |
|---------------------|--------|---------|
| <b>Auto mode</b>    |        | 999 hPa |
| <b>Sensitivity</b>  | Normal |         |
| <b>Speed</b>        | HI     |         |
| <b>Minimum</b>      | Off    |         |
| <b>Duration</b>     | Off    |         |
| ----- Graphic ----- |        |         |
| ----- Back -----    |        |         |

Parameter  
Auto mode

| Parameter                 | Meaning  |
|---------------------------|--|
| Sensitivity               | Setting affects processing speed:<br>Low Fast; large amounts of uncritical solvents<br>Normal Normal; basic setting for almost all distillations<br>High Slow; small amounts, for solvents with tendency to foam |
| Speed (%)                 | <b>VARIO®</b> : Motor speed limitation during tracking.<br>Adjustment range: 1–100; HI*  |
| Minimum (mbar, Torr, hPa) | <b>VARIO®</b> : Vacuum setting; once reached, controller stops the <b>VARIO®</b> pump.<br>Adjustment range: Off; Auto**; 2–1060  |
| Duration (Min)            | Presetting process runtime from <b>Start</b> on.<br>Adjustment range: Off; 1–1440  |
| Delay (Min)               | Delay time for an optional coolant valve.<br>Adjustment range: Off; 1–300  |

\* HI mode: optimum speed for the respective pressure, recommended setting.

\*\* Complete solvent evaporation will be detected and the process will then be stopped.

**Application example – rotary evaporator**

Application example for Auto mode

Use *Minimum* to prevent rotary evaporator from receiving re-evaporation from the flask. Set *Minimum* value to the vapor pressure of the solvent at ambient temperature.

**7.1.4 Program**

Meaning

Up to 10 individual programs including vacuum and time presettings can be loaded, edited, and stored.

**Menu – Program**

→ Example  
Operation menu  
Program

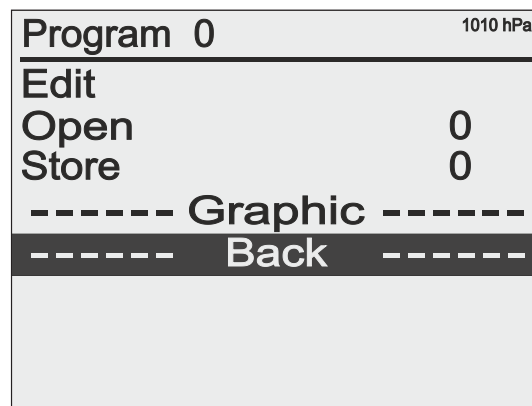

Parameter Program

| Parameter                    | Meaning  |
|------------------------------|--|
| Edit                         | Edit program with presettings for a process cycle or edit an existing program.                                   |
| Open                         | Load the selected program.   |
| Store                        | Store the program under the selected number. (memory capacity for up to 10 programs)                             |
| Hysteresis (mbar, Torr, hPa) | Only for VMS or in-line valve with vacuum pump: control range for 2-point control. Adjustment range: Auto; 1–300 |
| Delay                        | Delay time for an optional coolant valve. Adjustment range: Off; 1–300   |

**Hysteresis values Auto**

Factory settings for Hysteresis

| Set vacuum (mbar) | 5 | 10 | 50 | 80 | 100 | 200 | 500 | 700 | 900 | 1000 |
|-------------------|---|----|----|----|-----|-----|-----|-----|-----|------|
| Hysteresis (mbar) | 2 | 2  | 5  | 8  | 9   | 17  | 40  | 55  | 71  | 78   |

For further descriptions of program functions → see *Online Instructions for use*.

### 7.1.5 VACUULAN

Meaning Vacuum control, optimized for **VACUU-LAN®** vacuum networks by VACUUBRAND.

#### Menu **VACUULAN**

→ Example  
Display VACUULAN

|                            |            |          |
|----------------------------|------------|----------|
| <b>VACUULAN</b>            |            | 1008 hPa |
| <b>Set vacuum</b>          | <b>25</b>  | hPa      |
| <b>Switch on</b>           | <b>200</b> | hPa      |
| <b>Delay</b>               | <b>15</b>  | min      |
| ----- <b>Graphic</b> ----- |            |          |
| ----- <b>Back</b> -----    |            |          |

Parameter  
VACUULAN

| Parameter                   | Meaning  |
|-----------------------------|--|
| Set vacuum (mbar)           | Setting for lower vacuum level, which shall be reached easily when the vacuum network is not used.<br>Adjustment range: 1–1060 |
| Switch on (mbar, Torr, hPa) | Limit for pressure increase. If pressure exceeds this limit, the pump will begin to pump down.<br>Adjustment range: 26–1060    |
| Delay (Min)                 | Delay time for an optional coolant valve after reaching set vacuum.<br>Adjustment range: Off; 1–300                            |

#### 7.2 Program functions (see Online version of CVC manual)



Detailed information about programming  
→ see *Online Instructions for use 20901067*.

### 7.3 Configuration menu

Meaning In menu **Configuration** the controller parameters are set. This menu is also for adjusting the vacuum sensor and for loading **Defaults** settings.

#### Call up Configuration menu

→ Example  
Call up  
Configuration menu

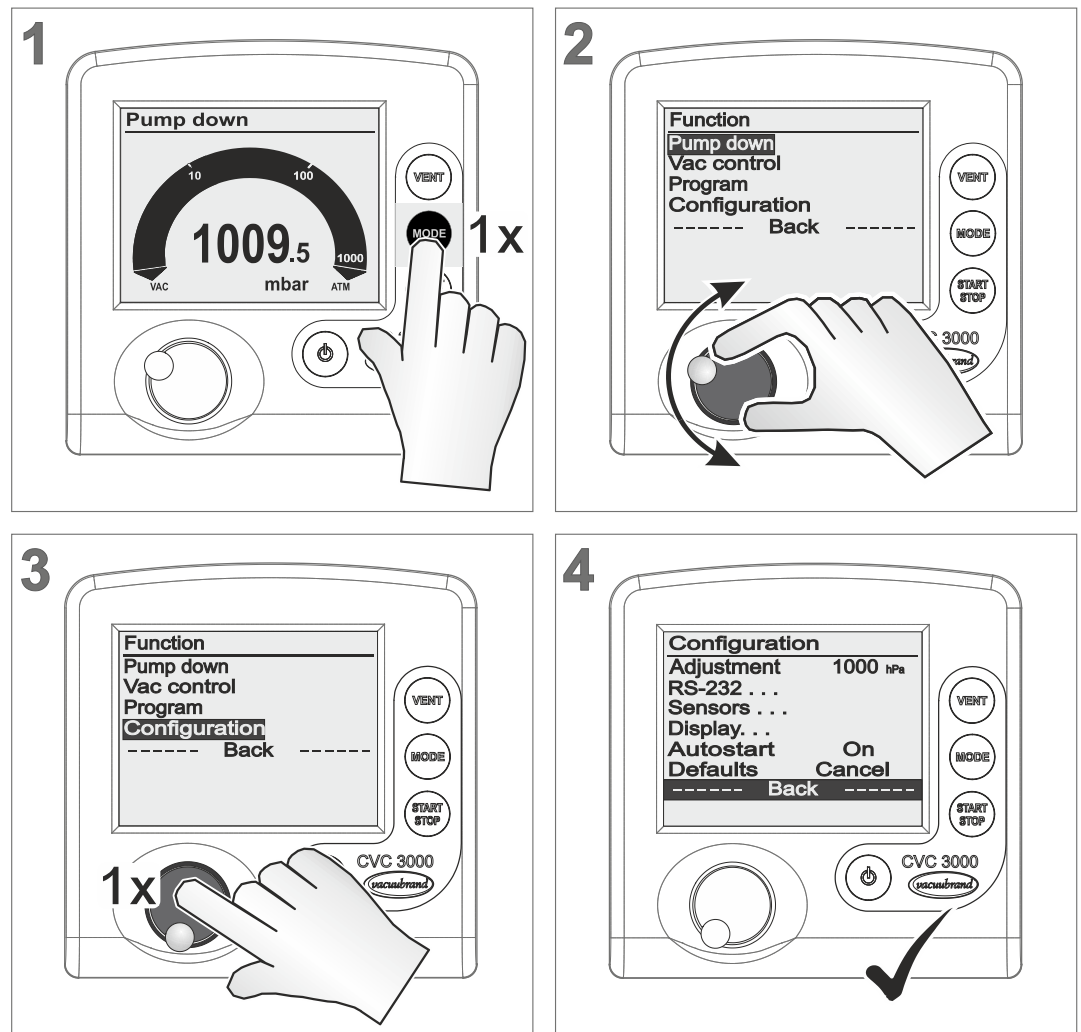

**Configuration** menu displayed.



After 20 seconds without action, the display will return automatically to pressure display.

### 7.3.1 Content selection

Specified content The following menu items of **Configuration** can be selected, activated and used.

#### Defaults

Defaults (standard)

| Selection | Meaning                                  |
|-----------|--|
| Cancel    | Leave menu item without default setting. |
| Load      | Load default settings.                   |

#### IMPORTANT!

If **Defaults Load** is activated all controller parameter will be reset to delivery status. Stored programs will be deleted.

#### Autostart

Auto start function

| Selection | Meaning   |
|-----------|---|
| Off       | After switching on power supply or after power failure the controller remains in <i>Stop</i> .<br>Press <b>Start/Stop</b> key to start the controller.  |
| On        | Once power is applied, the controller starts automatically with the settings before power failure.<br>The controller starts control directly without pressing <b>Start/Stop</b> key, if it previously was in running operation.<br>Recommended, if power supply is switched on from a central point or if power is switched on by an external switch. |

#### IMPORTANT!

Ensure, if **Autostart** is activated, that no hazardous situations may occur due to the automatic start of the process.

⇒ Check whether the **Autostart** feature can be used safely with the intended application.



### Adjustment

Sensor adjustment function

| Selection        | Meaning  |
|------------------|--|
| 1060–700<br>20–0 | Adjustment range of a vacuum sensor, internal or external at atmospheric pressure (1060–700) or under vacuum (20– ~0). |

For further descriptions about sensor adjustment  
 → see chapter **9.2 Sensor readjustment on page 79**

### 7.3.2 Submenus

#### Submenu – Display

Submenu Display

| Display          |         |
|------------------|---------|
| Brightness       | 100 %   |
| Contrast         | 40 %    |
| Sound            | On      |
| Units            | mbar    |
| Language         | English |
| ----- back ----- |         |

Adjustable display parameter

| Parameter  | Selection              | Meaning                                       |
|------------|------------------------|---|
| Brightness | 0–100 %                | Adjust backlight brightness of the display.   |
| Contrast   | 0–100 %                | Adjust display contrast.                      |
| Sound      | Off                    | Switch off keystroke sound and warning sound. |
|            | On                     | Switch on keystroke sound and warning sound.  |
| Units      | mbar                   | Preset pressure unit for user interface.      |
|            | Torr                   |   |
|            | hPa                    |   |
| Language   | 14 languages available | Preset pressure unit for user interface.      |

### Submenu – Sensors

In submenu **Sensors** all connected sensors are listed. The internal sensor is generally displayed as **Sensor**. External sensors are listed with sensor type name and address.

Submenu Sensors

| Sensors       |             |
|---------------|-------------|
| <b>Sensor</b> | 990.8 mbar  |
| VSP 1         | 4.1E+2 mbar |

Sensor selection

| Display     | Meaning   |
|-------------|---|
| Inverse     | <b>Sensor</b> = currently selected for pressure display.                        |
| Sensor type | Selection for displaying pressure on basic display (max. 8 sensors are listed). |

For descriptions about sensor address assignment

→ see *Online Instructions for use*.



The display switches automatically to the previous menu when selecting a sensor with the selection knob.

**Submenu – RS-232**

Submenu *RS-232* is applied for interface configuration, parameter adjustments and commands.

→ see also *Online Instructions for use*.

Submenu RS232

| RS-232           |       |
|------------------|-------|
| Baud             | 19200 |
| Parity           | 8-N-1 |
| Handshake        | None  |
| Remote           | Off   |
| ----- back ----- |       |

Adjustable RS232 parameter

| Parameter | Selection | Meaning   |
|-----------|-----------|---|
| Baud      | 19200     | Default setting for transmission speed. The baud rate of data transfer of transmitter and receiver must correspond. |
|           | 9600      |   |
|           | 4800      |   |
|           | 2400      |   |
| Parity    | 8-N-1     | Default setting for parity check, a method for error detection  |
|           | 7-O-1     |   |
|           | 7-E-1     |   |
| Handshake | RTS-CTS   | Preset for continuous data transmission without loss – flow control.  |
|           | Xon-Xoff  |   |
|           | None      |   |
| Remote    | Off       | Control commands not enabled, only queries possible   |
|           | On        | Connection for communication via RS 232 interface enabled.  |

**IMPORTANT!**

When selecting *Remote On* the controller itself is only operable via an external device. All keys of the control panel except key *On/Off* are locked.

VACUU·CONTROL® detects automatically, if *Remote* is activated or deactivated and retains that setting.

Icon on controller display

| Icon  | Meaning   |
|---|---|
|  | PC icon? Controller in remote operation!<br>Reset Remote: <b>Switch-off</b> Remote (switch off and on controller, press selection knob shortly while booting, select <b>Configuration/RS232/Remote</b> and adjust <b>Off</b> ). |

**7.4** *Function menu (see Online version of CVC manual)*

**7.5** *Program functions (see Online version of CVC manual)*



Detailed descriptions about function menu with address assignment or about differential pressure measurement

→ see *Online Instructions for use 20901067*.

## 8 Resolving problems

### Technical support



Technical support ⇒ To identify errors and potential remedies, please refer to the troubleshooting table: ***Fault – Cause – Remedy on page 71***  
 In case you need additional assistance, please contact our [Service](#) department.

### 8.1 Error display

The major symbol for fault indication is the warning triangle. Additionally displayed icons and sounds refer to the cause of fault.

#### Safety alert symbol

Warning triangle

| Icon  | Meaning  |
|---|--|
|   | Flashing: Warning!<br><br>Where applicable with: <ul style="list-style-type: none"> <li>flashing component icon,</li> <li>warning sound (only when switched on) or</li> <li>flashing backlight.</li> </ul> |
|  | <ul style="list-style-type: none"> <li>in combination with number = Vacuubus address of the component which is defective.</li> </ul>   |





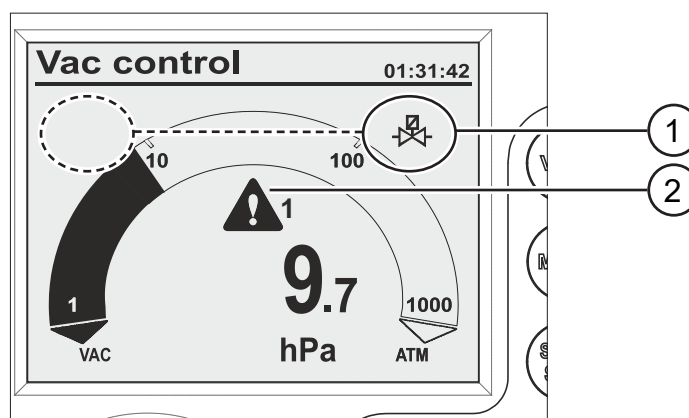













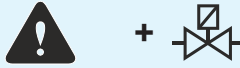

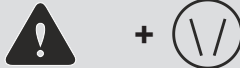

#### Example display in case of error

→ Example  
Error In-line valve 1

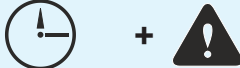

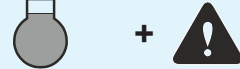
- 1 Possible positions for flashing component/display icon; here: warning In-line valve
- 2 Flashing: Warning triangle

## Combinations of flashing display icons

| Icon flash rate<br> | Fault and Meaning   | beep<br>when Sound<br>On  |
|--|---|---|
|                     | ▶ Limit pressure reached  | 1x     |
|                     | ▶ Overpressure  | 1x     |
|                     | ▶ Process time elapsed  | 1x     |
|                     | ▶ Venting valve   | 2x     |
|                     | ▶ In-line suction valve   | 3x     |
|                     | ▶ Coolant valve   | 4x     |
|                    | ▶ External sensor removed<br>▶ or defective   | 5x    |
|  | ▶ internal sensor defective   | 7x   |
|                   | ▶ Vario pump  | 6x   |
|                   | ▶ VACUULAN process pressure not reached within 99 hours.                                | 8x   |
|  | Digital I/O module:<br>▶ Fault indicator triggered or<br>▶ fault special configurations | 9x   |
|                   | ▶ Level sensor triggered; flask full  | 10x  |
|                   | ▶ Emission condenser Peltronic (too hot)  | 11x  |
|  | ▶ Analog I/O module   | 12x  |



A defective I/O module, which is configured as a remote module, does not trigger a warning alert. The control is stopped. Alert display by the flashing warning triangle.

## 8.2 Fault – Cause – Remedy

| Fault  | Possible cause  | Remedy  | Personnel                      |
|--|---|---|--------------------------------|
| <b>Sensitive process not controllable</b>                | <ul style="list-style-type: none"> <li>▶ Motor speed too high.</li> <li>▶ Pumping speed too high.</li> </ul>  | <ul style="list-style-type: none"> <li>✓ Reduce motor speed.</li> </ul>   | User, Specialist               |
| <b>Frequent error messages of connected components</b>   | <ul style="list-style-type: none"> <li>▶ Several controllers are connected.</li> <li>▶ Several VACUU·BUS components of the same type are using the same address.</li> </ul>   | <ul style="list-style-type: none"> <li>✓ Use only one controller for one VACUU·BUS system.</li> <li>✓ Only in <i>Function</i> menu Assign a new address number to VACUU·BUS® component</li> </ul>   | respon. Specialist             |
| <b>VENT key does not work</b>                            | <ul style="list-style-type: none"> <li>▶ <i>Venting</i> function deactivated.</li> </ul>  | <ul style="list-style-type: none"> <li>✓ Check why <i>Venting</i> is deactivated.</li> </ul>  | Specialist, respon. Specialist |
| <b>Internal air admittance valve cannot be triggered</b> | <ul style="list-style-type: none"> <li>▶ Setting of <i>int.Air V</i> in menu <i>Function</i> is switched <i>Off</i> or <i>Auto</i>.</li> <li>▶ External air admittance valve is connected, <i>and/or</i></li> <li>▶ External vacuum sensor is connected.</li> </ul> | <ul style="list-style-type: none"> <li>✓ Check if <i>Venting</i> by internal air admittance valve can be used without risk.</li> <li>✓ <i>Venting</i> safe? Enable the function in menu <i>Function/int.Air V</i>; adjustment: <i>Auto</i> or <i>On</i>.</li> </ul>       | Specialist, respon. Specialist |
| <b>Internal air admittance valve does not switch</b>     | <ul style="list-style-type: none"> <li>▶ Air admittance valve soiled.</li> </ul>  | <ul style="list-style-type: none"> <li>✓ Clean venting valve (air admittance valve), see <i>chapter 9.1 Cleaning on page 78</i></li> </ul>  | Specialist                     |
| <b>Function or menu item cannot be used</b>              | <ul style="list-style-type: none"> <li>▶ Function or menu item possibly only usable with short-cut (key combination).</li> </ul>  | <ul style="list-style-type: none"> <li>✓ Press the correct key combination; for descriptions of keys and short-cuts see <i>chapter: 5.1 Operating elements on page 35</i></li> </ul>  | Specialist, respon. Specialist |
| <b>Vario pump icon flashes</b>                           | <ul style="list-style-type: none"> <li>▶ VARIO pump and VMS are both connected at the same time.</li> <li>▶ VARIO pump defective.</li> <li>▶ VMS defective or cable is not connected.</li> <li>▶ Cable break.</li> </ul>  | <ul style="list-style-type: none"> <li>✓ Remove VMS from VARIO-pump and restart controller.</li> <li>✓ Check VARIO pump for defective parts.</li> <li>✓ Check VMS for defective parts.</li> <li>✓ Check cable connections.</li> <li>✓ Replace defective parts.</li> </ul> | Specialist                     |
| <b>Air admittance valve icon flashes</b>                 | <ul style="list-style-type: none"> <li>▶ External air admittance valve removed.</li> <li>▶ Plug disconnected.</li> <li>▶ External air admittance valve defective.</li> </ul>  | <ul style="list-style-type: none"> <li>✓ Check the connection.</li> <li>✓ Check plug connection.</li> <li>✓ Replace defective parts.</li> <li>✓ Use internal air admittance valve.</li> <li>✓ Reconfiguration without air admittance valve.</li> </ul>                    | Specialist                     |

| Fault   | ▶ Possible cause   | ✓ Remedy  | Personnel          |
|---|--|---|--------------------|
| <b>In-line suction valve icon flashes</b>               | <ul style="list-style-type: none"> <li>▶ In-line suction valve removed.</li> <li>▶ Plug disconnected.</li> <li>▶ In-line suction valve defective.</li> </ul>   | <ul style="list-style-type: none"> <li>✓ Check the connection.</li> <li>✓ Check plug connection.</li> <li>✓ Replace defective parts.</li> <li>✓ Reconfiguration without In-line suction valve.</li> <li>✓ Switch-off the controller; <b>On/Off</b> key.</li> <li>✓ Remove In-line suction valve and</li> <li>✓ switch on controller again.</li> </ul> | User, Specialist   |
| <b>Coolant valve icon flashes</b>                       | <ul style="list-style-type: none"> <li>▶ Coolant valve removed.</li> <li>▶ Coolant valve defective.</li> </ul>   | <ul style="list-style-type: none"> <li>✓ Check the connection.</li> <li>✓ Replace defective parts.</li> <li>✓ Reconfiguration without coolant valve.</li> </ul>   | Specialist         |
| <b>Level sensor icon flashes</b>                        | <ul style="list-style-type: none"> <li>▶ Level sensor triggered (flask full).</li> <li>▶ Level sensor removed.</li> <li>▶ Level sensor triggered with empty flask.</li> <li>▶ Cable break.</li> <li>▶ Level sensor defective.</li> </ul> | <ul style="list-style-type: none"> <li>✓ Empty flask/catch pot.</li> <li>✓ Check position of level sensor.</li> <li>✓ Adjust level sensor or delete the sensor from controller (by loading default).</li> <li>✓ Check plug connection.</li> <li>✓ Replace defective parts.</li> </ul>   | Specialist         |
| <b>Peltronic icon flashes</b>                           | <ul style="list-style-type: none"> <li>▶ Peltronic emission condenser too hot.</li> <li>▶ Plug disconnected.</li> </ul>  | <ul style="list-style-type: none"> <li>✓ Let the Peltronic emission condenser cool down.</li> <li>✓ Check plug connection.</li> </ul>   | User, Specialist   |
| <b>Title bar without text</b>                           | <ul style="list-style-type: none"> <li>▶ No controllable device connected (In-line suction valve, VMS, VARIO pump).</li> </ul>   | <ul style="list-style-type: none"> <li>✓ Check device connections and cable.</li> <li>✓ Replace defective parts.</li> <li>✓ Connect a controllable device to the controller.</li> <li>✓ Use the controller as measuring gauge.</li> </ul>   | Specialist         |
| <b>No key reaction – only On/Off, PC icon displayed</b> | <ul style="list-style-type: none"> <li>▶ Remote switched <i>On</i>.</li> <li>▶ Controller only controllable via connected external end device (via RS232).</li> </ul>  | <ul style="list-style-type: none"> <li>✓ Reset Remote: <b>Switch-off</b> Remote (switch off and on controller, press selection knob shortly while booting, select <b>Configuration/RS232/Remote</b> and adjust <b>Off</b>).</li> <li>✓ Control controller via end device.</li> </ul>  | Specialist         |
| <b>No reaction to key actuation</b>                     | <ul style="list-style-type: none"> <li>▶ Controller defective</li> </ul>   | <ul style="list-style-type: none"> <li>✓ Contact <a href="#">SAV</a> and</li> <li>✓ return device for repair.</li> </ul>  | respon. Specialist |



| Fault                          | ▶ Possible cause  | ✓ Remedy  | Personnel             |
|--------------------------------|---|---|-----------------------|
| No display                     | <ul style="list-style-type: none"> <li>▶ Controller switched off.</li> <li>▶ Power supply disconnected.</li> <li>▶ Power supply not correctly connected.</li> <li>▶ Mains voltage failure.</li> <li>▶ Controller defective</li> <li>▶ Cable break.</li> </ul>   | <ul style="list-style-type: none"> <li>✓ Switch on the controller; <b>On/Off</b> key.</li> <li>✓ Check plug connection and wall power supply for correct connection.</li> <li>✓ Replace defective parts.</li> <li>✓ Contact <a href="#">Service</a> and</li> <li>✓ return device for repair.</li> </ul>                         | Specialist            |
| Blank display                  | <ul style="list-style-type: none"> <li>▶ Too many devices connected, e. g., valves.</li> </ul>  | <ul style="list-style-type: none"> <li>✓ Power input of all connected devices may not exceed the maximum power consumption of the controller:                             <ul style="list-style-type: none"> <li>- controller with wall power supply max. 30 W,</li> <li>- Controller + VARIO max. 25 W.</li> </ul> </li> </ul> | respon.<br>Specialist |
|                                | <ul style="list-style-type: none"> <li>▶ Short circuit of a connected device.</li> </ul>  | <ul style="list-style-type: none"> <li>✓ Replace defective parts.</li> </ul>  |                       |
|                                | <ul style="list-style-type: none"> <li>▶ Short circuit at RS232 interface.</li> <li>▶ Controller defective</li> </ul>   | <ul style="list-style-type: none"> <li>✓ Check RS232 plug connection.</li> <li>✓ Contact <a href="#">Service</a> and</li> <li>✓ return device for repair.</li> </ul>  |                       |
| Incorrect pressure display     | <ul style="list-style-type: none"> <li>▶ Humidity inside the vacuum sensor.</li> <li>▶ Vacuum sensor soiled.</li> <li>▶ Vacuum sensor not adjusted.</li> <li>▶ Vacuum sensor not correctly adjusted.</li> </ul>   | <ul style="list-style-type: none"> <li>✓ Identify and remove source of humidity.</li> <li>✓ Dry the vacuum sensor, e. g., by pumping down.</li> <li>✓ Clean the vacuum sensor, see <i>chapter .9.1 Cleaning on page 78.</i></li> <li>✓ Readjust vacuum sensor.</li> </ul>   | User,<br>Specialist   |
| Digital pressure gauge flashes | <ul style="list-style-type: none"> <li>▶ Pressure display flashing with 0.0:                             <ul style="list-style-type: none"> <li>- vacuum adjustment not correctly carried out.</li> </ul> </li> <li>▶ Pressure display flashing:                             <ul style="list-style-type: none"> <li>- Overpressure! Pressure &gt; 1060 mbar.</li> </ul> </li> </ul> | <ul style="list-style-type: none"> <li>✓ Readjust internal or external vacuum sensor, see <i>chapter .9.2 Sensor readjustment on page 79.</i></li> </ul> <p><b>⚠WARNING!</b><br/>Risk of bursting.<br/>⇒ Discharge the system immediately by venting.</p>   | Specialist            |
| No digital pressure reading    | <ul style="list-style-type: none"> <li>▶ External vacuum sensor defective.</li> <li>▶ External vacuum sensor removed.</li> <li>▶ Internal vacuum sensor defective.</li> </ul>   | <ul style="list-style-type: none"> <li>✓ Replace defective parts.</li> <li>✓ Reconnect external vacuum sensor.</li> <li>✓ Contact <a href="#">Service</a> and</li> <li>✓ return device for repair.</li> </ul>   | respon.<br>Specialist |

| Fault   | Possible cause  | Remedy  | Personnel                      |
|---|---|---|--------------------------------|
| <b>Sensors submenu is permanently displayed</b>                 | ▶ Submenu <i>Sensors...</i> does not automatically switch back to previous display.                                 | ✓ Select the required sensor by turning and pressing selection knob.  | User, Specialist               |
| <b>After loading defaults <i>Language selection</i> appears</b> | ▶ Special factory settings have been loaded.  | ✓ Set language and pressure unit.<br><b>IMPORTANT!</b> Check if the loaded default settings are suitable for your vacuum apparatus. | respon. Specialist             |
| <b>Error I/O module</b>   | ▶ Plug disconnected.<br>▶ An error occurred in the system, the I/O module passed the error alert to the controller. | ✓ Check plug connection.<br>✓ Remedy external fault.  | Specialist, respon. Specialist |
| <b>VSP sensor displays wrong values</b>                         | ▶ VSP sensor configured as VSK.   | ✓ Use menu <i>Function/Vacuubus</i> to reconfigure the sensor as VSP.   | Specialist, respon. Specialist |
| <b>Controller in operation, pressure display flashes</b>        | ▶ VSK sensors are measuring negative difference pressure.   | ✓ Select an other vacuum sensor in menu <i>Sensors</i> .  |                                |

| Action required                                  | Cause  | Remedy   |
|--|--|--|
| <b>Elapsed process time</b>                      | ▶ All program steps are completed.<br>▶ Program end reached. | ✓ Acknowledge indication by pressing <i>Start/Stop</i> key.  |
| <b>Flashing clock icon</b>                       | ▶ Elapsed process time                                       | ✓ Acknowledge indication by pressing <i>Start/Stop</i> key.  |
| <b>Pump down stops, flashing arrow down icon</b> | ▶ Pressure below preset minimum value.                       | ✓ Acknowledge indication by pressing <i>Start/Stop</i> key.<br>✓ If possible readjust presetting (min.). |
| <b>Vac control stops, flashing arrow up icon</b> | ▶ Preset maximum value exceeded.                             | ✓ Acknowledge indication by pressing <i>Start/Stop</i> key.<br>✓ If possible readjust presetting (max.). |
| <b>Program -</b>                                 | ▶ Program not yet stored.                                    | ✓ Store program under a free program number.   |

## 8.3 Controller Reset

### Auto reset

---

Automatic reset    The following error indications will be reset automatically with remedy:

- Overpressure
- Process time elapsed
- Limit pressure reached
- Error air admittance valve
- Error Peltronic

### Active reset

---

Reset after action    Several error indications need to be reset manually. Depending on the fault severity different actions are required.

⇒ Press **Start/Stop** key to reset the following error indications:

- In-line suction valve error
- Coolant valve error
- External vacuum sensor removed
- I/O module activated **Error indication**
- external error indicator has triggered via Digital I/O module; assigned as **Error**.
- Level sensor triggered

⇒ Load **Defaults** (standard factory setting) to reset the following error indications:

- Missing set value presetting or VACUU·BUS plug disconnected via Digital I/O module; assigned as **Remote**.
- Level sensor removed and/or VACUU·BUS plug disconnected.

→ see also chapter: **7.3 Configuration menu on page 63** for loading **Defaults**.

**IMPORTANT!** ⇒ Note the settings of stored programs, before loading *Default*.

**Load *Default* settings**

Load factory settings

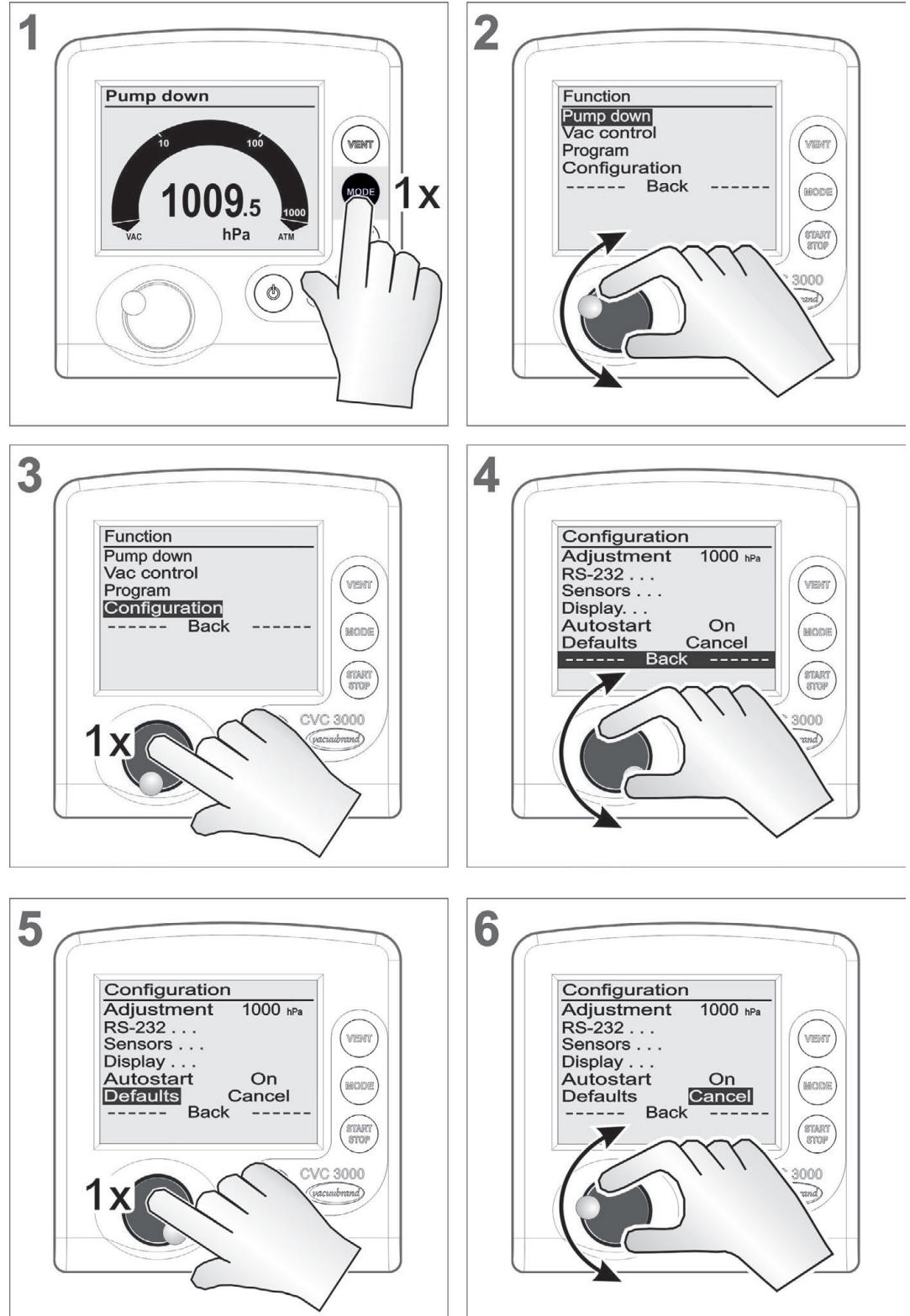

Load factory settings

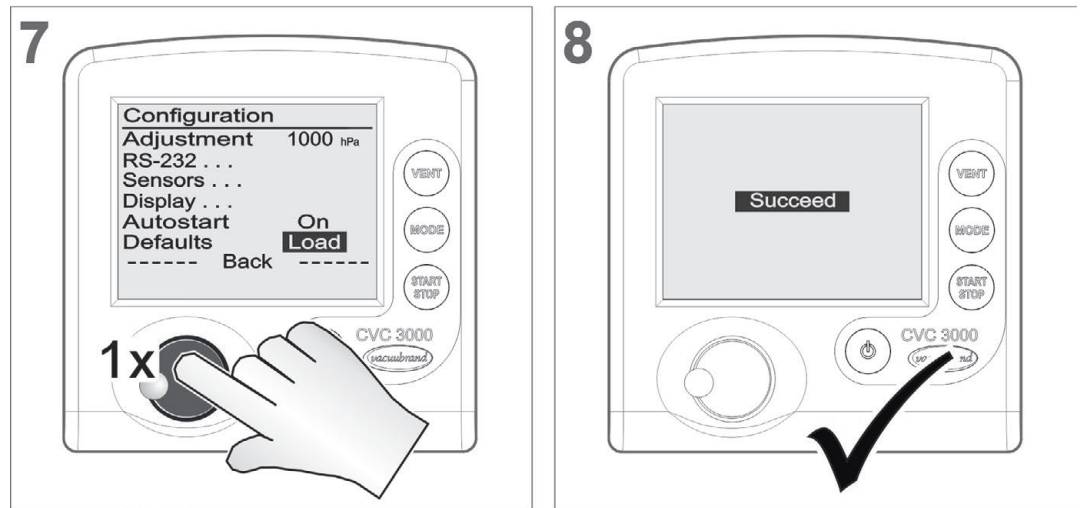

## 8.4 Error of external components

Error messages for defective external components such as In-line suction valve, vacuum sensor, etc. cannot be reset.

⇒ Replace defective accessories or

⇒ send defective accessories for repair to your local supplier or to our [Service](#).

## 9 Cleaning and maintenance

### 9.1 Cleaning

#### IMPORTANT!

This chapter does not contain descriptions for the decontamination of the controller. This chapter describes only simple cleaning and care measures.

#### 9.1.1 Controller

##### Clean surface



⇒ Clean soiled surface with a clean, slightly wetted cloth. To moisten the cloth we recommend water or mild soap.

#### 9.1.2 Venting valve

##### Clean venting<sup>1</sup> valve

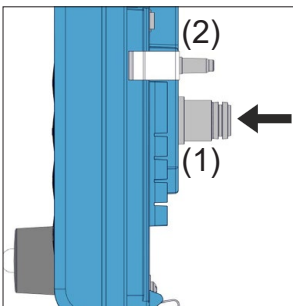

1. Apply slight overpressure of dry air or inert gas to the vacuum port (1).
2. Press the **VENT** key several times until gas escapes through the venting port (2).
3. Repeat this procedure until you hear the clicking of the valve and a gas stream is noticeable at the venting port (2).

#### 9.1.3 Internal sensor

##### Clean internal sensor

1. Fill a small amount of solvent via the vacuum port (1) in the controller, e. g., cleaning solvent.
2. Let the solvent react for a few minutes.
3. Drain the solvent.
  - ☑ Dissolved substances or discolorations in the solvent are possible.
4. Repeat this procedure until no more pollutants are in the solvent.
5. Let the controller dry.
6. Readjust the internal (vacuum) sensor.

<sup>1</sup> -> air admittance valve

## 9.2 Sensor readjustment

### NOTICE

**For readjustment the reference pressures need to be known with certainty**

**In the pressure range 20 – 700 mbar (15 – 525 Torr) no adjustment is possible.**

- ⇒ Check the accuracy of the pressure sensor in case of irregularities in the pressure display.
- ⇒ Readjust the sensor in two steps: at atmospheric pressure and under vacuum.

Do not adjust at atmospheric pressure, if the pressure at the location of the device is not exactly known (pay attention to height above sea level).

Any kind of pollution of the vacuum system, e. g., oil, substances, or humidity could falsify the adjustment.

- ⇒ Clean polluted sensors before readjustment.

### Adjustment at atmospheric pressure

Adjustment at  
atmospheric  
pressure

An adjustment at atmospheric pressure is only possible if the pressure is higher than > 700 mbar (> 525 Torr).

1. Vent the measurement connection of the controller or in case the connected external vacuum sensor VSK 3000.
2. Make sure that the vacuum sensor (internal or external) is really at atmospheric pressure.
3. Determine the exact atmospheric pressure of your location, e. g., by barometer, inquiry at the meteorological office or the airport.
4. Call up menu **Configuration**.
5. Turn the **selection knob** and place the bar marking on **Adjustment**.
6. Press the **selection knob**.
  - Marking jumps to numeric value.
7. Adjust the exactly determined local atmospheric pressure by turning the **selection knob**.
8. Press the **selection knob**.
  - Sensor adjusted to atmospheric pressure.

### Adjustment under vacuum

Adjustment under vacuum

An adjustment under vacuum is only possible if the pressure is lower than  $< 20$  mbar ( $< 15$  Torr) absolute.

1. Evacuate the measurement connection of the controller or in case the connected external vacuum sensor VSK 3000 to a pressure  $< 0,1$  mbar.

#### **IMPORTANT!**

Adjustment under vacuum with an actual pressure higher than  $0,1$  mbar ( $0.1$  Torr) reduces the accuracy of the measurement. If the pressure is significantly higher than  $> 0,1$  mbar ( $> 0.1$  Torr) the adjustment to a reference pressure is recommended.

2. Call up menu **Configuration**.
3. Turn the **selection knob** and place the bar marking on **Adjustment**.
4. Press the **selection knob**.
  - Marking jumps to numeric value.
5. Adjust the pressure value to 0 by turning the **selection knob**.
6. Press the **selection knob**.
  - Sensor adjusted under vacuum.

#### **NOTICE**

**The readjustment of a VSP 3000 can only be carried out in warmed-up state.**

Adjustment is not possible during the warm-up time.

- ⇒ Use a high vacuum pump for the adjustment of a VSP sensor.
- ⇒ After connection to power supply and after the pressure has reached  $< 10^{-3}$  mbar, wait 20 minutes before adjusting the VSP sensor.
- ⇒ Carry out the adjustment in the same order as described above for VSK.



### Adjustment at a reference pressure

Adjustment at  
reference pressure

Instead of adjustment under vacuum to a pressure  $< 0,1$  mbar ( $< 0.1$  Torr), adjustment to a precisely known reference pressure within the range of 0 – 20 mbar (0 – 15 Torr) is possible.

1. Evacuate the measurement connection of the controller or in case the connected external vacuum sensor VSK 3000 to a pressure in the range of 0 – 20 mbar (0 – 15 Torr).
2. Call up menu **Configuration**.
3. Turn the **selection knob** and place the bar marking on **Adjustment**.
4. Press the **selection knob**.
  - Marking jumps to numeric value.
5. Adjust the pressure value to the actual reference pressure by turning the **selection knob**.
6. Press the **selection knob**.
  - Sensor adjusted to reference pressure.

#### **IMPORTANT!**

The measurement uncertainty of the reference pressure will directly affect the measurement uncertainty of the controller.

If the nominal ultimate vacuum of a diaphragm pump is used as reference vacuum, the accuracy of the controller might be doubtful. The diaphragm pump may not achieve the specified vacuum (due to condensate, poor condition, failure of valves or diaphragm, leaks).

For further descriptions about **Adjustment**

→ see chapter: **7.3 Configuration menu on page 63**

## 10 Appendix

### 10.1 Technical information

Technical information

|                        |   |
|------------------------|---|
| <b>Product</b>         |   |
| Vacuum controller      | <b>Vacuum Controller CVC 3000</b>   |
| Internal vacuum sensor | Ceramic diaphragm (alumina), capacitive, gas independent, absolute pressure |

#### 10.1.1 Technical data

Technical data

|   |                         |                         |
|---|-------------------------|-------------------------|
| <b>Ambient conditions</b>   |                         | (US)                    |
| Working temperature   | 10–40 °C                | 50–104°F                |
| Transport- and storage temperature  | -10–60 °C               | 14–140°F                |
| Altitude, max.  | 3000 m above sea level  | 9840 ft above sea level |
| Relative humidity   | 30–85 %, non condensing |                         |
| Degree of protection IEC 60529 (controller front)                         | IP 20 (IP 42)           |                         |
| Degree of protection UL 50E   |                         | type 1                  |
| Avoid condensation or contamination by dust, liquids, or corrosive gases. |                         |                         |

|                                     |   |  |
|-------------------------------------|---|--|
| <b>Plug-in power supply</b>         | <b>30 W</b>   | <b>25 W</b>  |
| Input voltage                       | 100–240 VAC   | 100–240 VAC  |
| Frequency                           | 50–60 Hz  | 50–60 Hz   |
| Power consumption, max.             | 0,8 A   | 0,7 A  |
| Output current, max.                | 1,25 A  | 1,05 A   |
| Output voltage, short circuit proof | 24 VDC  | 24 VDC   |
| Weight                              | 0.3 kg  | 0.14 kg  |
| Dimensions L x B x H                | 108 mm x 58 mm x 34 mm<br>4.3 in. x 2.3 in. x 1.4 in. | 71 mm x 57 mm x 33 mm<br>2.8 in. x 2.2 in. x 1.3 in. |
| Cable length, approx.               | 2 m (79 in.)  |  |
| Power plug                          | AC, replaceable: CEE/UK/US/AUS                        |  |

|  |                |                |
|--|----------------|----------------|
| <b>Electrical data – CVC 3000</b>                  |                | (US)           |
| Supply voltage, max.                               | 24 VDC (±10 %) | 24 VDC (±10 %) |
| Power, max.  | 3,4 W          | 3.4 W          |
| max. admissible current total for connected valves | 4 A            | 4 A            |

Technical data  
basic device

|  |  |                |
|--|--|----------------|
| Port (interface)   | RS 232 SUB-D 9 poles   |                |
| Remote control, optional                                       | VACUU·CONTROL®   |                |
| <b>Vacuum data</b>   |  |                |
| <b>CVC 3000, internal vacuum sensor</b>                        | (US)   |                |
| ATEX approval if the ATEX marking is shown on the rating plate | II 3/- G Ex h IIC T3 Gc X<br>Internal Atm. only<br>Tech.File: VAC-EX02 |                |
| Inner part (pumped gases)                                      |  |                |
| Measuring range, absolute                                      | 1080–0,1 mbar  | 810–0.1 Torr   |
| max. control range   | 1060–0,1 mbar  | 795–0.1 Torr   |
| Resolution   | 0,1 mbar   | 0.1 Torr       |
| <b>max. admissible media temperature (gas):</b>                |  |                |
| Temporarily  | 80 °C  | 176°F          |
| Continuous operation   | 40 °C  | 104°F          |
| Measurement uncertainty  | < ±1 mbar  | < ±0.75 Torr   |
| Temperature coefficient  | < ±0,07 mbar/K   | < ±0.05 Torr/K |
| <b>External vacuum sensor VSK 3000</b>                         |  |                |
| max. admissible pressure, absolute                             | 1,5 bar  | 1125 Torr      |
| <b>Venting</b>   |  |                |
| max. admissible pressure, absolute                             | 1,2 bar  | 900 Torr       |
| <b>Gas connections</b>   |  |                |
| CVC built-in version   | Fitting for PTFE tube 10/8 mm  |                |
| CVC table top version  | Fitting for PTFE tube 10/8 mm or hose nozzle for flexible tube DN 6/10 |                |
| Venting  | Hose nozzle for flexible tube $d_i = 4-5$ mm                           |                |

Technical data  
package for fine  
vacuum control

|  |                               |                              |
|--|-------------------------------|------------------------------|
| <b>Vacuum data (only differing data)</b> |                               |                              |
| <b>CVC 3000 with external VSP 3000</b>   | (US)                          |                              |
| Measuring range, absolute                | 1000–1x 10 <sup>-3</sup> mbar | 750–1x 10 <sup>-3</sup> Torr |
| max. control range                       | 1000–1x 10 <sup>-3</sup> mbar | 750–1x 10 <sup>-3</sup> Torr |
| <b>External vacuum sensor VSP 3000</b>   |                               |                              |
| max. admissible pressure, absolute       | 1,5 bar                       | 1125 Torr                    |
| Cable, length                            | 2 m                           | 7 ft                         |

## Technical data

| <b>Venting</b>                     |   |          |
|------------------------------------|---|----------|
| max. admissible pressure, absolute | 1,2 bar   | 900 Torr |
| without internal venting valve     |   |          |
| <b>Display</b>                     |   |          |
| Type                               | LC display (LCD)                                    |          |
| Brightness control                 | yes   |          |
| Pressure display                   | switchable: mbar, Torr, hPa                         |          |
| <b>Weight and dimensions*</b>      |   | (US)     |
| Weight (built-in)                  | 440 g   | 0.97 lb  |
| Weight with foot (table top)       | 570 g   | 1.3 lb   |
| Dimensions                         | 123 mm x 124 mm x 83 mm<br>5 in. x 5 in. x 3.5 in.  |          |
| Dimensions with foot               | 144 mm x 124 mm x 115 mm<br>6 in. x 5 in. x 4.5 in. |          |

\* without wall power supply

### 10.1.2 Product comparison CVC 3000

#### Product comparison CVC 3000

| Product name               | Vacuum controller | internal venting valve | external venting valve | internal vacuum sensor | external vacuum sensor | lower measuring limit (mbar) | Measuring principle - capacitive | Measuring principle - Pirani | Measuring principle - cold cathode | Measuring principle gas type independent | ATEX category 2 | ATEX category 3 internal Atm. only |
|----------------------------|-------------------|------------------------|------------------------|------------------------|------------------------|------------------------------|----------------------------------|------------------------------|------------------------------------|--|-----------------|------------------------------------|
| <b>CVC 3000</b>            | ✓                 | ✓                      | x                      | ✓                      | x                      | 0.1                          | ✓                                | -                            | -                                  | ✓  | -               | ✓                                  |
| <b>CVC 3000 detect</b>     | ✓                 | ✓                      | x                      | ✓                      | x                      | 0.1                          | ✓                                | -                            | -                                  | ✓  | -               | ✓                                  |
| <b>CVC 3000 + VSK 3000</b> | ✓                 | ✓                      | x                      | -                      | ✓                      | 0.1                          | ✓                                | -                            | -                                  | ✓  | -               | ✓                                  |
| <b>CVC 3000 + VSP 3000</b> | ✓                 | -                      | x                      | -                      | ✓                      | 1x 10 <sup>-3</sup>          | -                                | ✓                            | -                                  | -  | -               | -                                  |

x = optionally

### 10.1.3 Rating plate



- ⇒ In case of malfunction, please note type and serial number on the rating plate.
- ⇒ When contacting our [Service](#) department, name us product type and serial number. With this information we can offer selective support and advice for your product.

#### Rating plate CVC 3000

Rating plate

|                                 |  |
|---------------------------------|--|
| Manufacturer                    | VACUUBRAND GMBH + CO KG                                  |
| Type/Date of construction/Month | CVC 3000      20... / ...                                |
| Serial number                   | SN .....   |
| Power supply                    | ... V ...  |
| Electrical power                | ... W  |
| Compatible to VACUU-BUS         | VACUU-BUS  |
| <a href="#">ATEX spec</a> *     | Internal Atm. only                                       |
| Address                         | Tech File: .....   |
|                                 | Alfred-Zippe-Str. 4<br>97877 Wertheim<br>Made in Germany |

\* Group and category, marking G (gas), type protection, explosion group, temperature class (additionally see: [Approval for ATEX equipment](#)).

### 10.1.4 Wetted parts

Wetted parts

| Component                      | Wetted materials                     |
|--------------------------------|--------------------------------------|
| Vacuum connection, hose nozzle | PP                                   |
| Sensor                         | Aluminium oxide ceramic              |
| Sensor housing                 | PPS/Glass fiber                      |
| Sensor seal                    | chemically resistant fluoroelastomer |
| Venting valve seal             | FFKM                                 |

## 10.2 Interface commands (see Online version of CVC manual)



Detailed descriptions about the complete interface commands  
→ see *Online Instructions for use 20901067*.

### 10.2.1 Pin assignment (RS232)

#### Sub-D panel connector

SUB-D 9 poles

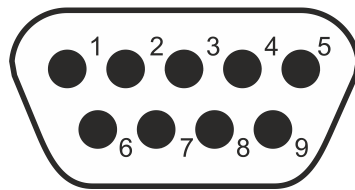

Sub-D 9 poles  
(rear side of CVC 3000)

| PIN | Name | Operation         | PIN | Name | Operation                                 |
|-----|------|-------------------|-----|------|---|
| 1   | DCD  | ---               | 6   | DSR  | ---                                       |
| 2   | RxD  | Received data     | 7   | RTS  | Transmission request                      |
| 3   | TxD  | Transmission data | 8   | CTS  | Ready to send                             |
| 4   | DTR  | +10 V             | 9   | RI   | +5 V ( <i>Bluetooth, remote control</i> ) |
| 5   | GND  | Mass              | -   | ---  | ---                                       |

### 10.3 Ordering information

|                                     |  |                                    |          |
|-------------------------------------|--|------------------------------------|----------|
| Ordering information<br>CVC         | <b>Vacuum controller</b>   | Order-N°                           |          |
|                                     | <b>CVC 3000</b> table top version  | 20683160                           |          |
|                                     | <b>CVC 3000</b> built-in version   | 20636595                           |          |
|                                     | <b>CVC 3000 + VSP 3000</b> (package for fine vacuum control)                     | 20635983                           |          |
| Ordering information<br>spare parts | <b>Spare parts</b>   | Order-N°                           |          |
|                                     | Vacuum sensor (vacuum gauge head)  |                                    |          |
|                                     | VSK 3000, 1080-0,1 mbar  | 20640530                           |          |
|                                     | VSP 3000 (Pirani), $1 \times 10^3 - 1 \times 10^{-3}$ mbar                       | 20636163                           |          |
|                                     | VACUU·VIEW, Vacuum gauge with integrated vacuum sensor, 1100-0.1 mbar            | 20683220                           |          |
|                                     | VACUU·VIEW extended, Vacuum gauge with integrated vacuum sensor, 1100-0.001 mbar | 20683210                           |          |
|                                     | VACUU·SELECT Sensor  | 20700020                           |          |
|                                     | VACUU·SELECT Sensor without air valve  | 20700021                           |          |
|                                     | In-line isolation valve (electromagnetic vacuum valve)                           |                                    |          |
|                                     | VV-B 6, 24 VDC, VACUU·BUS  | 20674290                           |          |
|                                     | VV-B 6C, 24 VDC, VACUU·BUS   | 20674291                           |          |
|                                     | VV-B 15C, KF 16, VACUU·BUS   | 20674210                           |          |
|                                     | VV-B 15C, KF 25, VACUU·BUS   | 20674215                           |          |
|                                     | Coolant valve VKW-B, VACUU·BUS   | 20674220                           |          |
|                                     | Air admittance valve VBM-B / KF 16, VACUU·BUS                                    | 20674217                           |          |
|                                     | Y adapter VACUU·BUS  | 20636656                           |          |
|                                     | Extension cable VACUU·BUS, 2m  | 20612552                           |          |
|                                     | Wall duct VACUU·BUS  | 20636153                           |          |
|                                     | Cable RS 232C, 9-poles, Sub-D  | 20637837                           |          |
|                                     | Installation kit CVC 3000 (spring clips + screws)                                | 20636593                           |          |
|                                     | Level sensor (for round bottom flask 500 ml)                                     | 20699908                           |          |
|                                     | Digital I/O interface module VACUU·BUS   | 20636228                           |          |
|                                     | Analog I/O interface module VACUU·BUS  | 20636229                           |          |
|                                     | Analog I/O interface module 4–20mA/0–10V VACUU·BUS                               | 20635425                           |          |
|                                     | Vacuum management module VMS-B, 100-230 V, 3.5 A, CEE                            | 20676030                           |          |
|                                     | Ordering information<br>VACUU·CONTROL®   | <b>Remote control</b>              | Order-N° |
|                                     |  | <b>VACUU·CONTROL®</b> WLAN version | 20683110 |
|                                     |  | <b>VACUU·CONTROL®</b> LAN version  | 20683120 |

| Ordering information accessories | Accessories   | Order-N° |
|----------------------------------|---|----------|
|                                  | Selection knob  | 20612091 |
|                                  | Plug-in rubber foot   | 20638901 |
|                                  | Spring clip   | 20636782 |
|                                  | Wall power supply plug 30 W, 24 V; with adapters                                  | 20612090 |
|                                  | Wall power supply plug 25 W, 24 V; with adapters                                  | 20612089 |
|                                  | Hose nozzle   | 20636045 |
|                                  | Hose  | 20636046 |
|                                  | Locking ring 10 mm for knurled nut M14 x 1 (637657)                               | 20637658 |
|                                  | Round head screw 4 x 18   | 20636947 |
|                                  | O-ring 28 mm x 2 mm   | 20636975 |
|                                  | Knurled nut M14 x 1 for hose fitting DN <sup>x</sup> 10/8mm, without locking ring | 20637657 |

<sup>x</sup> conversion - example:  $d_i = 10 \text{ mm} = \text{DN } 10$

### Source of supply

International sales offices and specialized trade

Purchase original accessories and spare parts from your specialized distributor or through international sales offices of **VACUUBRAND GMBH + CO KG**.



- ⇒ Information about the complete product range are available in the current [product catalog](#).
- ⇒ For orders, questions about vacuum control and optimal accessories, please contact your specialized distributor or an [international sales office](#) of **VACUUBRAND GMBH + CO KG**.



## 10.4 Service

Service range Take advantage of the comprehensive service range of **VACUUBRAND GMBH + CO KG**.



### Service in detail

- Product guidance and practical solutions,
- fast delivery of spare parts and accessories,
- professional maintenance,
- immediate repairs processing,
- service on the spot (available upon request),
- calibration (DAkkS accredited),
- return, disposal.

⇒ Please visit our website for further information:  
[www.vacuubrand.com](http://www.vacuubrand.com).

### Service handling

Meet the terms of  
service

1. Contact your local dealer or our service department<sup>1</sup>.
2. Request a RMA number for your order.
3. Clean your product thoroughly and if necessary decontaminate it professionally.
4. Please fill in the form **Health and Safety Clearance** completely

Send in your product  
(return)

5. Return your product including:
  - RMA number,
  - repair order,
  - form **Health and Safety Clearance**,
  - short error description.



- ⇒ Reduce downtime, speed up the handling. Keep the required data and documents ready when contacting the service department.
- ▶ Your order can be quickly and easily processed.
  - ▶ Hazards can be excluded.
  - ▶ A short description or photos may help for error location.

<sup>1</sup> -> Phone: +49 9342 808-5660, Fax: +49 9342 808-5555,  
 Mail to: [service@vacuubrand.com](mailto:service@vacuubrand.com)

## 10.5 Glossary

|                            |   |
|----------------------------|---|
| <b>HI mode</b>             | scores maximum pumping speed and low ultimate vacuum with the pump and optimum speed for the respective pressure (automatic speed reduction at ultimate vacuum).  |
| <b>Hysteresis</b>          | Regulates control performance of 2-point control in mode Vac control and Program. The hysteresis determines the threshold to which the actual value may differ from the setpoint. A too small hysteresis value leads to a frequent switching cycle. A too large hysteresis value leads to imprecise vacuum control.               |
| <b>Peltronic®</b>          | Electronic emission condenser; the Peltronic® condenses solvent vapors without external coolant such as water or dry ice. Cooling is achieved by Peltier elements. All wetted materials are highly resistant against chemicals.   |
| <b>Periphery equipment</b> | in this manual: accessories and apparatus connected to the vacuum system such as vacuum valves, vacuum pumps and recipients; see also chapter <b>4.2.3 VACUU·BUS®</b> .   |
| <b>Quick adaption</b>      | during running operation an operation mode can be tuned without calling up the corresponding operation menu. Usable for the modes <b>Vac control – set vacuum adaption</b> and <b>Pump down – VARIO® motor speed adaption</b> .   |
| <b>VACUU·BUS</b>           | digital communication system of <b>VACUUBRAND</b> . Possible components are: pressure/vacuum sensors, valves, level sensors, I/O modules; <b>VARIO®</b> pumps. When connecting several VACUU·BUS components of the same type it is necessary to regard that these components require different address numbers for communication. |
| <b>VACUU·CONTROL®</b>      | web-based remote control enables the monitoring and control of vacuum pumping units via computers or mobile devices such as Smartphones. With the new LAN or WLAN adapter all pumping units and vacuum systems equipped with the CVC 3000 vacuum controller or a DCP 3000 vacuum gauge can be integrated into a computer network. |
| <b>VMS-B module</b>        | The Vacuum-Management-System module VMS-B switches a vacuum pump according to actual demand from one or two applications. It is operated by one or two vacuum controllers CVC 3000. If two CVC 3000 are connected to the VMS-B it switches off the pump only if both applications do not need a vacuum supply anymore             |

## 10.6 Index

|   |       |                                      |       |
|---|-------|--------------------------------------|-------|
| <b>A</b>                                    |       | First steps .....                    | 6     |
| Action step.....                            | 10    | First steps on delivery status ..... | 6     |
| Active reset.....                           | 75    | Foreseeable misuse .....             | 13    |
| Adapt set vacuum.....                       | 55    | Functionality .....                  | 23    |
| Additional notes .....                      | 9     | <b>G</b>                             |       |
| Adjustment.....                             | 65    | Goods arrival .....                  | 21    |
| Adjustment at<br>atmospheric pressure ..... | 79    | <b>H</b>                             |       |
| Adjustment at reference pressure ...        | 81    | Handling .....                       | 42    |
| Adjustment under vacuum.....                | 80    | Handling CVC 3000.....               | 42    |
| ATEX category.....                          | 17    | Handling instruction.....            | 10    |
| Automatic reset.....                        | 75    | Health and Safety Clearance.....     | 18    |
| Auto mode .....                             | 48    | <b>I</b>                             |       |
| Auto start function.....                    | 64    | Icons .....                          | 9     |
| <b>B</b>                                    |       | Improper use .....                   | 12,13 |
| Back (return).....                          | 43    | Included materials .....             | 21    |
| Bar graphic .....                           | 37    | Included materials (Standard) .....  | 21    |
| bar marking.....                            | 42    | Input (data entry) .....             | 43    |
| bench-top type.....                         | 25    | Installation .....                   | 25    |
| built-in version .....                      | 26    | Installation conditions .....        | 25    |
| <b>C</b>                                    |       | Interface.....                       | 11    |
| Call-up graphic .....                       | 53    | <b>K</b>                             |       |
| Call-up Mode menu .....                     | 47    | Key combinations .....               | 36    |
| Cleaning and maintenance.....               | 78    | <b>L</b>                             |       |
| Condensate .....                            | 16    | Load Default .....                   | 76    |
| Configuration menu .....                    | 63    | Load factory settings .....          | 76    |
| Connection examples .....                   | 32    | <b>M</b>                             |       |
| Connect vacuum line .....                   | 31    | Menu – Auto mode .....               | 60    |
| Contact .....                               | 8     | Menu display in general.....         | 41    |
| Content selection.....                      | 64    | menu items (Configuration) .....     | 64    |
| Continous venting.....                      | 50    | Menu – Program.....                  | 61    |
| Control panel keys.....                     | 35    | Menu – Pump down.....                | 58    |
| Copyright .....                             | 7     | Menu – Vac control.....              | 59    |
| Country-specific                            |       | Menu VACUULAN .....                  | 62    |
| Interchangeable plug .....                  | 29    | Mode.....                            | 47    |
| CVC 3000 .....                              | 11    | Mode menu.....                       | 48    |
| <b>D</b>                                    |       | Motor speed.....                     | 56    |
| Defaults (standard).....                    | 64    | multi-voltage power supply .....     | 29    |
| Digitale Druckanzeige.....                  | 70    | <b>N</b>                             |       |
| digital pressure gauge .....                | 37    | Navigation.....                      | 42    |
| Direct installation .....                   | 26    | <b>O</b>                             |       |
| Display.....                                | 65    | Operation.....                       | 42,45 |
| Display graphic (curve).....                | 53    | Operation menus .....                | 57    |
| Display icons .....                         | 38    | Operation modes .....                | 24,48 |
| display parameter .....                     | 65    | optimize vacuum control.....         | 28    |
| <b>E</b>                                    |       | Optimizing operation mode.....       | 57    |
| Electrical connection.....                  | 29    | Ordering information.....            | 87    |
| Environmental protection.....               | 20    | <b>P</b>                             |       |
| Error display .....                         | 40,69 | Particles, liquids, dust.....        | 16    |
| Examples of use .....                       | 27    | Peripherals .....                    | 11    |
| Explanation of usage conditions X ..        | 18    | Pin assignment (RS232).....          | 86    |
| Explosion danger.....                       | 15    | Pressure display .....               | 37    |
| explosive mixtures .....                    | 15    | Pressure graph.....                  | 53    |
| <b>F</b>                                    |       | Pressure history.....                | 53    |
| Fault – Cause – Remedy.....                 | 71    |                                      |       |
| fine vacuum control .....                   | 83    |                                      |       |

|                                      |       |                                 |       |
|--------------------------------------|-------|---------------------------------|-------|
| Product comparison.....              | 84    | <b>V</b>                        |       |
| Product description.....             | 21    | Vac control.....                | 48    |
| Program.....                         | 48    | VACUU•BUS.....                  | 33    |
| Program functions.....               | 62    | VACUU•BUS accessories.....      | 34    |
| Protective clothing.....             | 15    | VACUU•BUS components.....       | 34    |
| Pump down.....                       | 48    | VACUU•BUS principle.....        | 33    |
|                                      |       | VACUU•CONTROL.....              | 16    |
| <b>Q</b>                             |       | VACUULAN.....                   | 48,62 |
| Quality standards.....               | 15    | Vacuum connection.....          | 31    |
|                                      |       | Vacuum controller CVC 3000..... | 21    |
| <b>R</b>                             |       | vacuum port.....                | 31    |
| Rating plate.....                    | 85    | VACUU•VIEW.....                 | 34,87 |
| Remote.....                          | 67    | VACUU•VIEW extended.....        | 34,87 |
| Remote icon.....                     | 67    | Vent function.....              | 49    |
| Requirements for services.....       | 19    | Venting.....                    | 50    |
| Reset.....                           | 75    |                                 |       |
| Reset Remote.....                    | 67,72 | <b>W</b>                        |       |
| Residual energy.....                 | 16    | Warning levels.....             | 8     |
| Responsibility Assignment Matrix.... | 14    | Warning triangle.....           | 69    |
| RMA-N°.....                          | 19    | Wetted parts.....               | 85    |
| RMA number.....                      | 89    |                                 |       |
| RS-232.....                          | 67    |                                 |       |
| RS232 parameter.....                 | 67    |                                 |       |
| RS232 port.....                      | 40    |                                 |       |
|                                      |       |                                 |       |
| <b>S</b>                             |       |                                 |       |
| Safety and service.....              | 18    |                                 |       |
| safety instructions.....             | 12    |                                 |       |
| sales offices.....                   | 88    |                                 |       |
| Selection.....                       | 42    |                                 |       |
| Selection knob.....                  | 35    |                                 |       |
| Select language and units.....       | 6     |                                 |       |
| Select operation mode.....           | 47    |                                 |       |
| Sensor readjustment.....             | 79    |                                 |       |
| Sensors.....                         | 66    |                                 |       |
| Sensor selection.....                | 66    |                                 |       |
| Service.....                         | 89    |                                 |       |
| shortcuts.....                       | 36    |                                 |       |
| Specification and features.....      | 23    |                                 |       |
| Specified content.....               | 64    |                                 |       |
| Start controlling.....               | 49    |                                 |       |
| Start CVC 3000.....                  | 49    |                                 |       |
| Sub-D.....                           | 22    |                                 |       |
| Sub-D Einbaustecker.....             | 86    |                                 |       |
| Submenu – Display.....               | 65    |                                 |       |
| Submenu RS232.....                   | 67    |                                 |       |
| Submenus.....                        | 42    |                                 |       |
| Submenu Sensors.....                 | 66    |                                 |       |
| Switch-off CVC 3000.....             | 45    |                                 |       |
| Switch on CVC 3000.....              | 45    |                                 |       |
| Switch-on/-off.....                  | 45    |                                 |       |
| Symbols.....                         | 9     |                                 |       |
| System venting.....                  | 50    |                                 |       |
|                                      |       |                                 |       |
| <b>T</b>                             |       |                                 |       |
| Table top version.....               | 25    |                                 |       |
| Target groups.....                   | 14    |                                 |       |
| Technical data.....                  | 82    |                                 |       |
| Technical information.....           | 82    |                                 |       |
| Technical support.....               | 69    |                                 |       |
|                                      |       |                                 |       |
| <b>U</b>                             |       |                                 |       |
| User permissions.....                | 14    |                                 |       |

## 10.7 Certifications

### 10.7.1 EC Declaration of Conformity

**EU-Konformitätserklärung**  
**EC Declaration of Conformity**  
**Déclaration CE de conformité**



Hersteller / Manufacturer / Fabricant:

VACUUBRAND GMBH + CO KG · Alfred-Zippe-Str. 4 · 97877 Wertheim · Germany

Hiermit erklärt der Hersteller, dass das Produkt konform ist mit den Bestimmungen der Richtlinien:

Hereby the manufacturer declares that the device is in conformity with the directives:

Par la présente, le fabricant déclare, que le dispositif est conforme aux directives:

- 2014/35/EU
- 2014/30/EU
- 2014/34/EU (außer / except / sauf: 20635028)
- 2011/65/EU, 2015/863

■ Messgerät / Vacuum gauge / Vacuomètre

Typ / Type / Type: **CVC 3000**

Artikelnummer / Order number / Numéro d'article: **20635027, 20635028, 20636310, 20683160, 20699916, 22615721**

Seriennummer / Serial number / Numéro de série: Siehe Typenschild / See rating plate / Voir plaque signalétique

Angewandte harmonisierte Normen / Harmonized standards applied / Normes harmonisées utilisées:

DIN EN 61010-1:2020, IEC 61010-1:2010 (Ed. 3), DIN EN 61326-1:2013, DIN EN 1127-1:2019, DIN EN ISO 80079-36:2016, DIN EN IEC 63000:2019

Bevollmächtigter für die Zusammenstellung der technischen Unterlagen / Person authorised to compile the technical file / Personne autorisée à constituer le dossier technique: Dr. Constantin Schöler · VACUUBRAND GMBH + CO KG · Germany

Ort, Datum / place, date / lieu, date: Wertheim, 09.12.2021

(Dr. Constantin Schöler)

*Geschäftsführer / Managing Director /  
Gérant*

ppa.

(Jens Kaibel)

*Technischer Leiter / Technical Director /  
Directeur technique*

**VACUUBRAND GMBH + CO KG**

Alfred-Zippe-Str. 4  
97877 Wertheim

Tel.: +49 9342 808-0

Fax: +49 9342 808-5555

E-Mail: [info@vacuubrand.com](mailto:info@vacuubrand.com)

Web: [www.vacuubrand.com](http://www.vacuubrand.com)

## 10.7.2 UKCA Declaration of Conformity

### Declaration of Conformity



Manufacturer:

VACUUBRAND GMBH + CO KG · Alfred-Zippe-Str. 4 · 97877 Wertheim · Germany

Hereby the manufacturer declares that the device is in conformity with the directives:

- Electrical Equipment (Safety) Regulations 2016 (S.I. 2016 No. 1101, as amended by S.I. 2019 No. 696)
- Electromagnetic Compatibility Regulations 2016 (S.I. 2016 No. 1091, as amended by S.I. 2019 No. 696)
- The Equipment and Protective Systems Intended for Use in Potentially Explosive Atmospheres Regulations 2016 (S.I. 2016 No. 1107, as amended by S.I. 2019 No. 696) (except: 20635028)
- The Restriction of the Use of Certain Hazardous Substances in Electrical and Electronic Equipment Regulations 2012 (S.I. 2012 No. 3032)

■ Vacuum gauge  
Type: **CVC 3000**

Order number: **20635027, 20635028, 20636310, 20683160, 20699916, 22615721**

Serial number: See rating plate

Harmonized standards applied:

- EN 61010-1:2010+A1:2019,  
EN 61326-1:2013,
- EN 1127-1:2019, EN ISO 80079-36:2016
- EN IEC 63000:2018

Person authorised to compile the technical file:

Dr. Constantin Schöler · VACUUBRAND GMBH + CO KG · Germany

Place, date: Wertheim, 09.12.2021

(Dr. Constantin Schöler)  
*Managing Director*

ppa.

(Jens Kaibel)  
*Technical Director*

**VACUUBRAND GMBH + CO KG**

Alfred-Zippe-Str. 4  
97877 Wertheim



Tel.: +49 9342 808-0

Fax: +49 9342 808-5555

E-Mail: [info@vacuubrand.com](mailto:info@vacuubrand.com)

Web: [www.vacuubrand.com](http://www.vacuubrand.com)

10.7.3 US/CAN Certificate

|  |  |   |
|--|--|---|
| <h1 style="margin: 0;">Certificate</h1>  |  |  |
| Certificate no.  | CU 72228817 01   |   |
| <b>License Holder:</b><br>VACUUBRAND GMBH + CO KG<br>Alfred-Zippe-Str. 4<br>97877 Wertheim<br>Deutschland        | <b>Manufacturing Plant:</b><br>VACUUBRAND GMBH + CO KG<br>Alfred-Zippe-Str. 4<br>97877 Wertheim<br>Deutschland |   |
| <b>Test report no.:</b> USA- 31880183 003  | <b>Client Reference:</b> Dr. A. Wollschläger   |   |
| <b>Tested to:</b><br>UL 61010-1:2012 R7.19<br>CAN/CSA-C22.2 NO. 61010-1-12 + GI1 + GI2 (R2017) + A1              |  |   |
| <b>Certified Product:</b> Measurement and control device for vacuum  | <b>License Fee - Units</b>   |   |
| Model : (1) VACUU VIEW; (2) VACUU VIEW extended;   | 7  |   |
| Designation : (3) VACUU SELECT; (4) VACUU SELECT complete;   |  |   |
| (5) VACUU SELECT Sensor;   |  |   |
| (6) VSP 3000; (7) CVC 3000; (8) VSK 3000;  |  |   |
| (9) VSK PV; (10) DCP 3000  |  |   |
| Rated Voltage: DC 24V; class III (all devices)   |  |   |
| Rated Power : (1+2) 1.3W; (3) 5.0W; (4) 13W; (5) 1.2W;   |  |   |
| (6) 1.6W; (7+10) 3.4W; (8+9) 0.12W   |  |   |
| Degree of : (7+10) IP20/Type 1 (UL50E)   |  |   |
| Protection : (3+4) IP40/Type 1 (UL50E)   |  |   |
| (5) IP41/Type 2 (UL50E)  |  |   |
| (1+2+6+8+9) IP54/Type 5 (UL50E)  |  |   |
| Appendix: 1, 1-13  | 7  |   |
| <b>Licensed Test mark:</b>   | <b>Date of Issue (day/mo/yr)</b>   |   |
|                               | 09/02/2023   |   |
| TUV Rheinland of North America, Inc., 12 Commerce Road, Newtown, CT 06470, Tel (203) 426-0888 Fax (203) 426-4009 |  |   |

## 10.7.4 Declaration of Conformity – China RoHS 2

VACUUBRAND®

### DECLARATION OF CONFORMITY – China RoHS 2

VACUUBRAND GMBH + CO KG has made reasonable efforts to ensure that hazardous materials and substances may not be used in its products.

In order to determine the concentration of hazardous substances in all homogeneous materials of the subassemblies, a “Product Conformity Assessment” (PCA) procedure was performed. As defined in GB/T 26572 the “Maximum Concentration Value” limits (MCV) apply to these restricted substances:

- Lead (Pb): 0.1%
- Mercury (Hg): 0.1%
- Cadmium (Cd): 0.01%
- Hexavalent chromium (Cr(+VI)): 0.1%
- Polybrominated biphenyls (PBB): 0.1%
- Polybrominated diphenyl ether (PBDE): 0.1%

### Environmentally Friendly Use Period (EFUP)

EFUP defines the period in years during which the hazardous substances contained in electrical and electronic products will not leak or mutate under normal operating conditions. During normal use by the user such electrical and electronic products will not result in serious environmental pollution, cause serious bodily injury or damage to the user's assets. The Environmentally Friendly Use Period for VACUUBRAND products is 40 years.



| MATERIAL CONTENT DECLARATION FOR VACUUBRAND PRODUCTS                                 |         |         |         |                |             |               |
|--|---------|---------|---------|----------------|-------------|---------------|
| 有毒有害物质或元素<br>Hazardous substances  |         |         |         |                |             |               |
| 部件名称<br>Part name  | 铅<br>Pb | 汞<br>Hg | 镉<br>Cd | 六价铬<br>Cr(+VI) | 多溴联苯<br>PBB | 多溴二苯醚<br>PBDE |
| 包装<br>Packaging  | 0       | 0       | 0       | 0              | 0           | 0             |
| 塑料外壳 / 组件<br>Plastic housing / parts   | 0       | 0       | 0       | 0              | 0           | 0             |
| 真空油<br>Vacuum oil  | 0       | 0       | 0       | 0              | 0           | 0             |
| 电池<br>Battery  | 0       | 0       | 0       | 0              | 0           | 0             |
| 玻璃<br>Glass  | X       | 0       | 0       | 0              | 0           | 0             |
| 电子电气组件<br>Electrical and electronic parts  | X       | 0       | 0       | 0              | 0           | 0             |
| 控制器 / 测量设备<br>Controller / measuring device  | X       | 0       | 0       | 0              | 0           | 0             |
| 金属外壳 / 组件<br>Metal housing / parts   | X       | 0       | 0       | 0              | 0           | 0             |
| 电机<br>Motor  | X       | 0       | 0       | 0              | 0           | 0             |
| 配件<br>Accessories  | X       | 0       | 0       | 0              | 0           | 0             |
| 此表格是按照SJ/T 11364-2014中规定所制定的。<br>This table is created according to SJ/T 11364-2014. |         |         |         |                |             |               |

Declaration of Conformity – China RoHS 2

V5\_September 2022

Copyright 2022



## VACUUBRAND®

- O: 表示该有毒有害物质在该部件所有均质材料中的含量均在GB/T 26572规定的限量要求以下。  
 O: Indicates that the above mentioned hazardous substance contained in all homogeneous materials of the part is below the required limit as defined in GB/T 26572.
- X: 表示该有毒有害物质至少在该部件某一均质材料中的含量超出GB/T 26572规定的限量要求。  
 X: Indicates that the above mentioned hazardous substance contained in at least one of the homogeneous materials of this part is above the required limit as defined in GB/T 26572.

电池、玻璃器皿和配件可能不属于所附设备所包含的内容，它们可能有各自单独的EFUP标记和/或可能正在维护其部件EFUP标记的更新。

Batteries, glassware and accessories might not be content of the enclosed device and may have its own EFUP-marking and/or might be maintaining parts with changing EFUP-marking.

除上表所示信息外，还需声明的是，这些部件并非是有意图用铅（Pb）、汞（Hg）、铬（Cd）、六价铬（Cr(+VI)）、多溴联苯（PBB）或多溴二苯醚（PBDE）来制造的。

Apart from the disclosures in the above table, the subassemblies are not intentionally manufactured or formulated with lead (Pb), mercury (Hg), cadmium (Cd), hexavalent chromium (Cr+VI), polybrominated biphenyls (PBB), and polybrominated diphenyl ethers (PBDE).

Products manufactured by VACUUBRAND may enter into further devices (e.g., rotary evaporator) or can be used together with other appliances (e.g., usage as booster pumps).

With these products and appliances in particular, please note the EFUP labeled on these products.

VACUUBRAND will not take responsibility for the EFUP of those products and appliances.

Place, date: Wertheim, 06 September 2022



(Dr. Constantin Schöler)  
 Managing Director



ppa. (Jens Kaibel)  
 Technical Director

## VACUUBRAND GMBH + CO KG

Alfred-Zippe-Str. 4  
 97877 Wertheim  
 Germany

Tel.: +49 9342 808-0  
 Fax: +49 9342 808-5555  
 E-Mail: info@vacuubrand.com  
 Web: www.vacuubrand.com





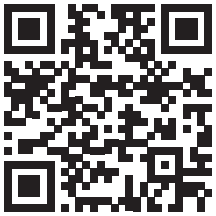
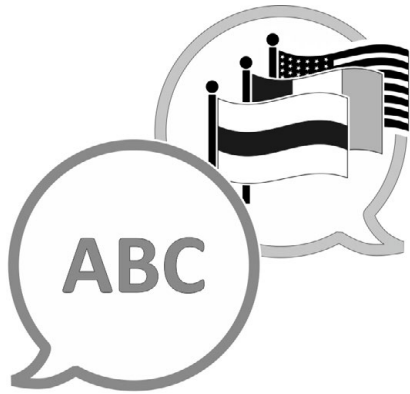

[VACUUBRAND > Support > Manuals](#)

Manufacturer:

**VACUUBRAND GMBH + CO KG**  
**Alfred-Zippe-Str. 4**  
**97877 Wertheim**  
**GERMANY**

Phone:

Head office +49 9342 808-0  
Sales +49 9342 808-5550  
Service +49 9342 808-5660

Fax: +49 9342 808-5555

Email: [info@vacuubrand.com](mailto:info@vacuubrand.com)

Web: [www.vacuubrand.com](http://www.vacuubrand.com)