

Chemistry diaphragm pump MD 1C

[Link to the website](#)



Product description

Three-stage chemistry-design diaphragm pumps are an excellent solution for continuous, oil-free pumping of corrosive gases and vapors and meet high requirements regarding ultimate vacuum. The three-stage construction provides the advantageous combination of high pumping speed and deep ultimate vacuum in a pump with a very small footprint. All parts in contact with pumped media are made of chemically resistant fluoroplastics. Well-proven PTFE sandwich diaphragms increase reliability and extend operating life. The MD 1C with gas ballast valve is optimally prepared for pumping easily condensable vapors (high boiling solvents).

Performance features

- outstanding chemical resistance and superior vapor tolerance
- exceptionally high performance even at low vacuum
- excellent ultimate vacuum even with gas ballast
- whisper quiet and ultra low vibration
- proven long diaphragm life, maintenance-free drive system

Ordering data

Product name	Nominal mains voltage mains frequency	Plug type	Articleno.
MD 1C	220-230 V 50-60 Hz 100-115 V 50-60 Hz	UK, IN	20696602

Items supplied

Pump completely mounted, ready for use, with manual.

Accessories

- Silencer with hose 5cm DN 8-10mm (20636588)
- Rubber vacuum tubing DN 8 mm (20686001)

Technical data

Max. pumping speed 50 Hz (mbar)	1.3 m ³ /h
Max. pumping speed 60 Hz (cfm)	0.88 cfm
Ultimate vacuum	2 mbar / 1.5 torr
Ultimate vacuum with gas ballast	4 mbar / 3 torr
Number of heads	4
Number of stages	3
Permissible ambient temperature range (operation)	10 - 40 °C
Permissible ambient temperature range (storage)	-10 - 60 °C
Max. outlet pressure (abs.)	1.1 bar
Inlet connection	Hose nozzle DN 8-10 mm
Outlet connection	Hose nozzle DN 8 mm
Rated motor power	0.08 kW
Rated speed 50/60 Hz	1500/1800 min ⁻¹
Protection class IEC 60529	IP 40
Dimensions (L x W x H)	338 mm x 142 mm x 223 mm
Weight	7.9 kg
Noise (sound pressure level) in dBA at 50 Hz or 1500 rpm/62% (VARIO)/1500 rpm (VARIO-SP)/12500 Upm (VACUU·PURE®)	41 dBA
ATEX conformity	II 3/- G Ex h IIC T3 Gc X Internal Atm. only
NRTL certification	Yes

Pumping speed graph at 50 Hz

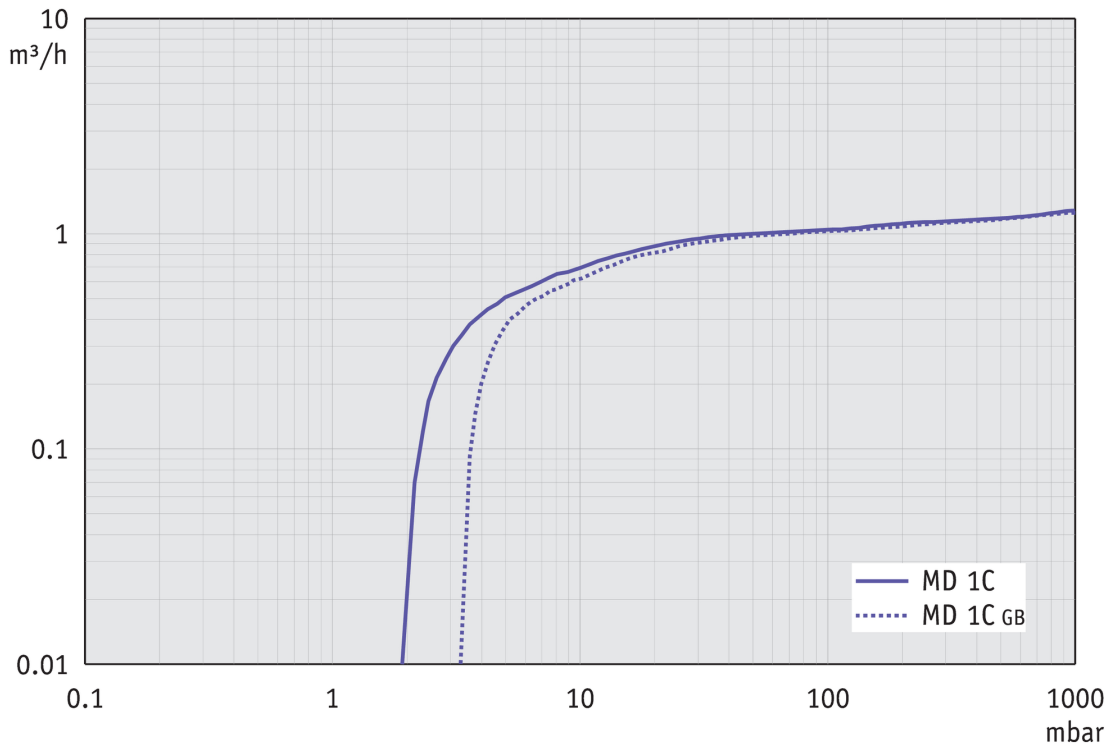

Pump down graph at 50 Hz (10 l volume)

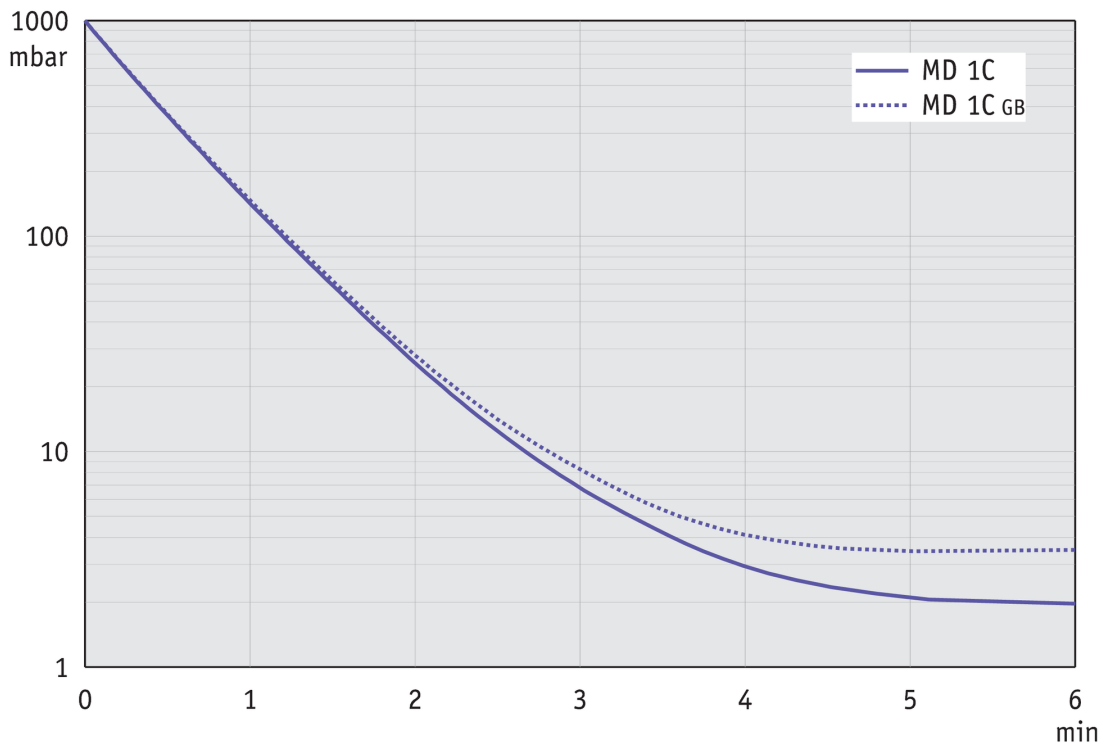

Pumping speed graph at 60 Hz

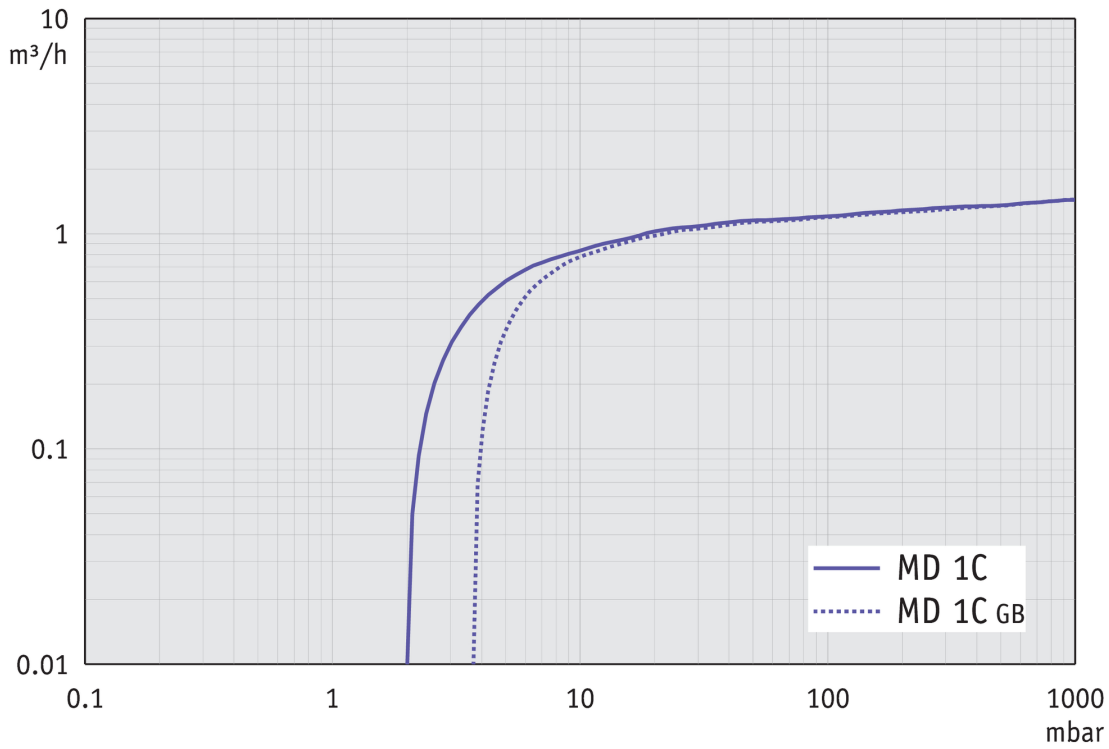

Pump down graph at 60 Hz (10 l volume)

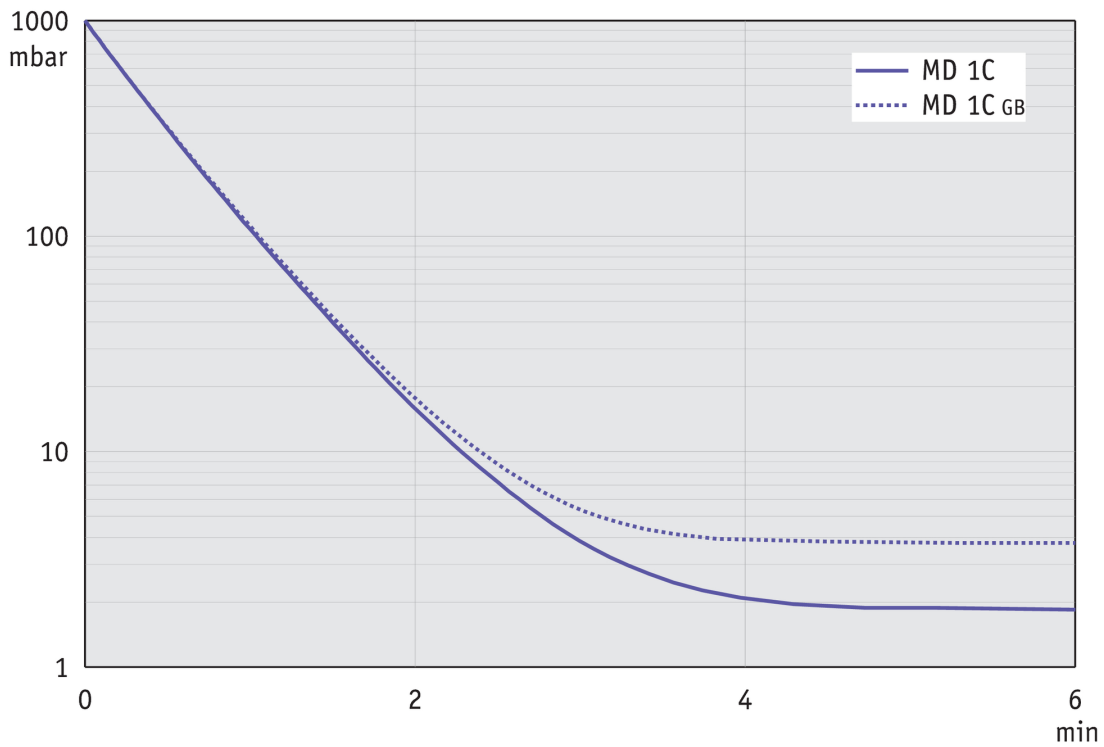

Dimension sheet

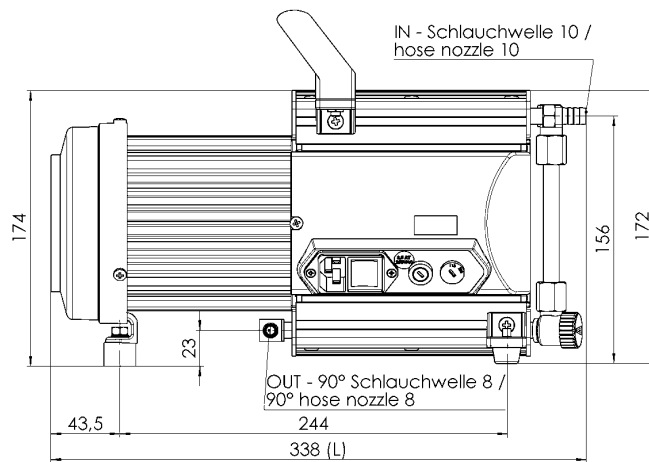
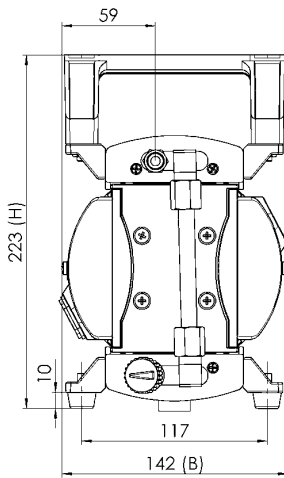
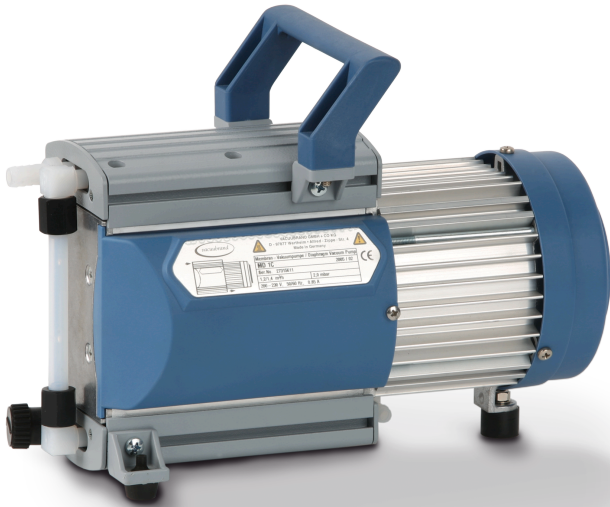

VACUUBRAND MD 1C
Version 03

Gewicht / weight ca. 7,9 kg

Alle Maße / all dimensions [mm]

VACUUBRAND GMBH + CO KG
P.O. Box 1664
97877 Wertheim
T +49 9342 808 5550
F +49 9342 808 5555

info@vacuubrand.com
www.vacuubrand.com

VACUUBRAND®

VACUUBRAND is part of the Brand group, a manufacturer of high-quality and innovative laboratory equipment and vacuum technology with a global team of approx. 1,000 employees.

With highly motivated and qualified employees, we manufacture the world's most comprehensive product family for vacuum generation, measurement and control for the rough and fine vacuum range in the laboratory.

All with one goal:

Enabling our customers to run reliable, safe and efficient processes. This is why we commit ourselves to continuous innovation, first-class performance, and outstanding quality.

Engineering excellence is central to our ability to deliver products and solutions renowned for their quality, durability, and reliability. Innovative technology, high quality materials and extensive testing deliver unmatched performance - engineered and manufactured in Germany.

Together with you, our experts will find the best solution for your application and provide you with first-class service along the way.

BRAND (Shanghai) Trading Co., Ltd.
Shanghai, China

T +86 21 6422 2318
info@brand.com.cn
china.brand.com.cn

BRAND Scientific Equipment Pvt. Ltd.
Mumbai, India

T +91 22 42957790
customersupport@brand.co.in
www.brand.co.in

BRANDTECH® Scientific, Inc.
Essex, CT. United States of America

T +1 860 767 2562
info@brandtech.com
www.brandtech.com